

**Burr-Brown**

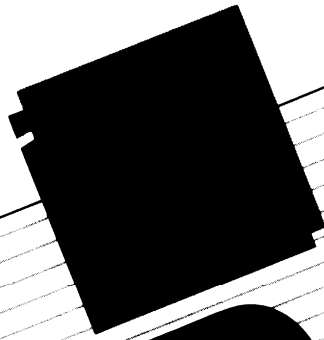

# **POWER SOURCES**

**HANDBOOK**  
Volume 1



# MODEL INDEX

---

PWR70 .....	29	PWR11XX .....	59
PWR71 .....	31	PWR13XX .....	61
PWR72 .....	33	PWR1546A .....	63
PWR74 .....	35	PWR1726 .....	66
PWR1XX .....	37	PWR510X .....	69
PWR2XX .....	39	PWR53XX Single .....	72
PWR3XX .....	41	PWR53XX Dual .....	74
PWR4XX .....	43	PWR53XX Triple .....	76
PWR5XX .....	45	PWR59XX .....	78
PWR6XX .....	47	PWR62XX .....	80
PWR7XX .....	50		
PWR8XX .....	53	PWS725/726 .....	82
PWR1017 .....	55	PWS740 .....	87

**Individual Product Data Sheets for models not listed here are available from your local Burr-Brown salesperson or representative. See the listing on the inside back cover.**

---

# **BURR-BROWN POWER SOURCES HANDBOOK**

---

**VOLUME 1**



—Credits—



which assisted in the preparation of the Glossary in this handbook.

LI-358  
©1989 Burr-Brown Corporation  
Printed in U.S.A.

Burr-Brown Corporation  
International Airport Industrial Park

<u>Mailing Address:</u>	<u>Street Address:</u>
PO Box 11400	6730 S. Tucson Blvd.
Tucson, AZ 85734	Tucson, AZ 85706

Tel: (602) 746-1111 • Twx: 910-952-1111  
FAX: (602) 889-1510 • Cable: BBRCORP • Telex: 66-6491

The information provided herein is believed to be reliable; however, BURR-BROWN assumes no responsibility for inaccuracies or omissions. BURR-BROWN assumes no responsibility for the use of this information, and all use of such information shall be entirely at the user's own risk. Prices and specifications are subject to change without notice. No patent rights or licenses to any of the circuits or products described herein are implied or granted to any third party. BURR-BROWN does not authorize or warrant any BURR-BROWN product for use in life support devices and/or systems.

# ***Contents***

---

INTRODUCTION & SELECTION GUIDES .....	5
WHERE TO GO FROM HERE: BURR-BROWN SALES & SERVICE .....	9
CUSTOM & MODIFIED PRODUCTS .....	11
QUALITY ASSURANCE & RELIABILITY .....	13
POWER CONVERSION GLOSSARY .....	15
APPLICATION NOTES .....	21
PRODUCT DATA SHEETS .....	29
SALES OFFICES .....	96



# INTRODUCTION & SELECTION GUIDES

---

Burr-Brown offers a wide selection of power conversion products. Hundreds of standard and unique DC/DC converters, including DIP sizes, higher wattage, and wide-input-range units are available. All carry Burr-Brown's guarantee of high quality and reliability.

The *Burr-Brown Power Sources Handbook* contains detailed Product Data Sheets for all of Burr-Brown's power conversion products. In addition, it includes supplementary data such as extensive Selection Guides, discussion of the advanced reliability programs available, a Glossary of power conversion terminology, and Application Notes for more effective use of these products. You'll also find information on how to get modified and custom products.

On the inside of the front cover is an index of all products in the handbook, listed in alphanumeric order. The inside back cover contains a directory of Burr-Brown sales offices and representatives.

## ABOUT THE SELECTION GUIDES

Use the following Selection Guides to compare the many products in this book. Then refer to the Product Data Sheet for full specifications. Models shown in **boldface** are new products.

## Selection Guides

### HIGH-ISOLATION DC/DC CONVERTERS

**Boldface = NEW**

Model	Test Voltage (AC, V <sub>PEAK</sub> 60Hz, 60s)	Rated Power (Watts)	Features	Page
<b>PWR1726</b>	<b>8000</b>	1.5	<b>High Isolation</b>	<b>66</b>
PWR70	5000	3	Small Size	29
PWS726	4950	450mW	High Isolation	82
PWR74	4000	3	Multichannel	35
<b>PWR13XX Series</b>	<b>3535</b>	1	<b>DIP Package</b>	<b>61</b>
PWR71	3000	3	Multichannel	31
PWR72	3000	3	Wide Input Range	33
PWR1XX Series	3000	450mW	General Purpose	37
PWR2XX Series	3000	1.5	General Purpose	39
PWR3XX Series	3000	2	Multichannel	41
PWR4XX Series	3000	3	Small Size	43
PWR6XX Series	3000	2	Regulated	47
PWR7XX Series	3000	5	Regulated	50
PWR1017	3000	3	Multichannel	55
PWS725	2121	450mW	High Isolation	82
PWS740	2121	0.9/Channel	Distributed Power	87

### DIP-PACKAGED DC/DC CONVERTERS

**Boldface = NEW**

Model	Regulation	Internal Filtering	Features	Page
<b>PWR11XX Series</b>	<b>No</b>	<b>Yes</b>	<b>Filtered</b>	<b>59</b>
<b>PWR13XX Series</b>	<b>No</b>	<b>No</b>	<b>High Isolation</b>	<b>61</b>
<b>PWR59XX Series</b>	<b>Yes</b>	<b>Yes</b>	<b>Filtered</b>	<b>78</b>

### MULTICHANNEL DC/DC CONVERTERS

**Boldface = NEW**

Model	Number of Channels	Number of Outputs Per Channel	Rated Power (Watts)	Features	Page
PWR1017	4	2	3	8 Outputs	55
PWR71	4	2	3	Small Size	31
PWR5XX Series	4	1 or 2	4	Small Size	45
PWR8XX Series	2	3 Total	5	5 ±12 or 5 ±15 V <sub>OUT</sub>	53
PWR74	2	2	3	High Isolation	35
PWR3XX Series	2	1 or 2	2	Small Size	41
<b>PWR53XX Series</b>	<b>1 or 2</b>	<b>1 or 2</b>	<b>15</b>	<b>Wide Input Range</b>	<b>72</b>
PWS740	8	2	0.9/Channel	Distributed Power	87



**LOW-NOISE DC/DC CONVERTERS**

**Boldface = NEW**

Model	Noise Out (mVp-p)		Rated Power (Watts)	Features	Page
	Typ	Max			
<b>PWR1546A</b>	<b>0.6</b>	<b>1.0</b>	<b>5</b>	<b>Ultra-Low Noise</b>	<b>63</b>
<b>PWR62XX Series</b>	<b>15</b>		<b>5.2</b>	<b>ECL Power</b>	<b>80</b>
<b>PWR59XX Series</b>	<b>20</b>		<b>2</b>	<b>DIP Package</b>	<b>78</b>
PWR6XX Series	30		3	Regulated	47
PWR7XX Series	30		5	Regulated	50
PWR74	40	100	3	High Isolation	35
<b>PWR1726</b>	<b>50</b>		<b>1.5</b>	<b>High Isolation</b>	<b>66</b>
<b>PWR11XX Series</b>	<b>50</b>		<b>3</b>	<b>DIP Package</b>	<b>59</b>
PWR1XX Series	50		2	General Purpose	37
PWR3XX Series	50		2	Multichannel	41
<b>PWR53XX Series</b>		<b>75</b>	<b>15</b>	<b>Wide Input Range</b>	<b>72</b>
PWR2XX Series	75		1.5	General Purpose	39
PWR70		80	3	High Isolation	29
PWR71		100	3	Multichannel	31
PWR4XX Series		100	3	Small Size	43
PWR1017		100	3	Multichannel	55

**WIDE-INPUT-RANGE DC/DC CONVERTERS**

**Boldface = NEW**

Model	Input Range (VDC)	Rated Power (Watts)	Features	Page
<b>PWR53XX Series</b>	<b>9-18</b>	<b>15</b>	<b>Single, Dual, &amp; Triple Outputs</b>	<b>72</b>
	<b>18-36</b>	<b>15</b>	<b>Single, Dual, &amp; Triple Outputs</b>	
	<b>36-72</b>	<b>15</b>	<b>Single, Dual, &amp; Triple Outputs</b>	
PWR72	5-22	3	Dual Outputs	33
PWS740	7-20	0.9/Channel	Distributed Power	87

**REGULATED DC/DC CONVERTERS**

**Boldface = NEW**

Model	Regulation		Rated Power (Watts)	Features	Page
	Line (%)	Load (%)			
<b>PWR1546A</b>	<b>±0.02</b>	<b>0.02</b>	<b>5</b>	<b>Low Noise</b>	<b>63</b>
PWR6XX Series	±0.02	0.04	2	General Purpose	47
PWR7XX Series	±0.02	0.04	5	General Purpose	50
PWR510X	±0.02	0.04	9	General Purpose	69
<b>PWR62XX Series</b>	<b>±0.04</b>	<b>0.06</b>	<b>5.2</b>	<b>ECL Power</b>	<b>80</b>
<b>PWR59XX Series</b>	<b>±0.3</b>	<b>0.4</b>	<b>2</b>	<b>DIP Package</b>	<b>78</b>
<b>PWR53XX Series</b>	<b>±0.2</b>	<b>1.0</b>	<b>15</b>	<b>Wide Input Range</b>	<b>72</b>

## Selection Guides

### UNREGULATED DC/DC CONVERTERS

**Boldface = NEW**

Model	Rated Power (Watts)	Package Size (Inches)	Features	Page
PWR1XX Series	450mW	1.0 x 1.0 x 0.4	General Purpose	37
PWS725	450mW	1.6 x 0.9 x 0.31	High Isolation	82
PWS726	450mW	1.6 x 0.9 x 0.31	High Isolation	82
<b>PWR13XX Series</b>	<b>1</b>	<b>24-pin DIP</b>	<b>High Isolation</b>	<b>61</b>
PWR2XX Series	1.5	1.0 x 1.0 x 0.4	General Purpose	39
<b>PWR1726</b>	<b>1.5</b>	<b>1.2 x 1.6 x 0.4</b>	<b>High Isolation</b>	<b>66</b>
<b>PWR11XX Series</b>	<b>2</b>	<b>24-pin DIP</b>	<b>Filtered</b>	<b>59</b>
PWR3XX Series	2	1.0 x 1.0 x 0.4	Multichannel	41
PWR70	3	1.0 x 1.0 x 0.4	High Isolation	29
PWR71	3	2.0 x 2.0 x 0.4	Multichannel	31
PWR72	3	1.0 x 1.0 x 0.4	Wide Input Range	33
PWR74	3	1.0 x 1.0 x 0.4	Multichannel	35
PWR4XX Series	3	1.0 x 1.0 x 0.4	General Purpose	43
PWR1017	3	2.0 x 2.0 x 0.4	Multichannel	55
PWR5XX Series	4	1.2 x 1.6 x 0.4	Multichannel	45
PWR8XX Series	5	1.2 x 1.6 x 0.4	Multichannel	53
PWS740	0.9/Channel	Components	Distributed Power	87

### DC/DC CONVERTERS BY WATTAGE

**Boldface = NEW**

Model	Rated Power (Watts)	Package Size (Inches)	Features	Page
<b>PWR53XX Series</b>	<b>15</b>	<b>2.5 x 3.5 x 0.7</b>	<b>Triple Output</b>	<b>72</b>
PWR510X	9	2.0 x 2.0 x 0.4	Regulated	69
<b>PWR62XX Series</b>	<b>5.2</b>	<b>2.0 x 2.0 x 0.4</b>	<b>ECL Power</b>	<b>80</b>
PWR7XX Series	5	2.0 x 2.0 x 0.4	Regulated	50
<b>PWR1546A</b>	<b>5</b>	<b>2.0 x 2.0 x 0.4</b>	<b>Ultra-Low Noise</b>	<b>63</b>
PWR8XX Series	5	1.2 x 1.6 x 0.4	Multichannel	53

# **WHERE TO GO FROM HERE: BURR-BROWN SALES & SERVICE**

---

## **GETTING TECHNICAL ASSISTANCE**

We have a large and competent field sales force, backed up by an experienced staff of technical applications specialists. They are eager to assist you in selecting the right product for your application. This free service is available from our Tucson-based headquarters and all sales offices.

## **GETTING PRODUCT DATA SHEETS AND OTHER TECHNICAL LITERATURE**

Product Data Sheets (PDSs) and manuals similar to those you see here, but perhaps containing more recent revisions, are available for most of the products in this book. To obtain any of these items, contact your local Burr-Brown salesperson or representative. See the list on the inside back cover.

## **HOW TO PLACE AN ORDER**

You can place orders via telephone, FAX, mail, TWX, or TELEX with any authorized Burr-Brown field sales office, sales representative, or our headquarters in Tucson. A complete list of sales offices is on the inside back cover of this book. When placing an order, please provide complete information, including model number with all option designations, product description or name, quantity desired, and ship-to and bill-to addresses. This will help us serve you most efficiently.

## **PRICES AND TERMS**

Contact your local Burr-Brown sales office for pricing. Prices and specifications are subject to change without notice.

For U.S.A. customers all prices are FOB Tucson, Arizona, U.S.A., in U.S. dollars. Applicable federal, state, and local taxes are extra. Terms are net 30 days.

## **QUOTATIONS**

Price quotations made by Burr-Brown or its authorized field sales representatives are valid for 30 days. Delivery quotations are subject to reconfirmation at the time of order placement.

## **RETURNS AND WARRANTY SERVICE**

When returning products for any reason, it is necessary to contact Burr-Brown prior to shipping for authorization and shipping instructions. In the U.S.A., contact our Tucson headquarters. In other countries, contact your local Burr-Brown sales office or representative. Please ship returned units prepaid and supply the original purchase order number and date, along with an explanation of the malfunction. Upon receipt of the returned unit, Burr-Brown will verify the malfunction and will inform you of the warranty status, cost to repair or replace, credits, and status of replacement units where applicable.

## **CUSTOM & MODIFIED PRODUCTS**

---

At Burr-Brown, we welcome the opportunity to discuss inquiries about special or custom OEM power conversion requirements. If you're faced with the need for unique mechanical or electrical characteristics, our outstanding engineering staff can solve your problem.

### **MODIFIED PRODUCTS**

If one of our standard products is close but won't quite do the job, consider a modified product. First find the standard product in this catalog that most closely reflects your requirements. Determine exactly what electrical or mechanical characteristics your application requires. For example, this might be a different input or output voltage, a certain pin-out, or special testing of a specific parameter for guaranteed qualification. Call your nearest Burr-Brown sales office for further investigation.

### **CUSTOM PRODUCTS**

If a standard product cannot be modified to meet your requirement, the next alternative is to consider a custom product. We have many types not listed in this catalog that have been built for one customer.

A custom product can also be designed to meet your special needs. But having a custom product designed for you may also present some disadvantages, so discussing the feasibility is essential. Let's talk. Prompt assistance is available by contacting your local Burr-Brown salesperson or representative listed on the inside back cover of this handbook.



## QUALITY ASSURANCE & RELIABILITY

---

All Burr-Brown DC/DC converters are manufactured using stringent in-process controls and quality inspections. Internal Quality Assurance Programs use the guidelines set forth in *MIL-I-45208A, Inspection System Requirements*. Each lot is fully traceable to incoming materials.

Burr-Brown's DC/DC converters are leading the industry in reliability. Our products have some of the highest predicted MTTFs for DC/DC converters. The Advanced Reliability Options available enhance reliability to even higher levels. For example, our industry standard PWR700A ( $V_{IN} = 5\text{VDC}$ ,  $V_{OUT} = 5\text{VDC}$ , Regulated, 5W) has a predicted MTTF of 1,371,486 hours (per MIL-HDBK-217 Rev. E, circuit-stress analysis method, +25°C, ground benign). Under /G screening that number rises dramatically to 2,338,585 hours. The PWR700A/T has a whopping 3,052,850 hours at +25°C! This is nearly 350 years!

Our Quality Assurance Department performs all predicted MTTF calculations per MIL-HDBK-217 Rev. E, circuit-stress analysis method. Some manufacturers only include "critical" components, or use the less realistic parts-count method. Company policy requires a predicted MTTF of at least 20,000 hours at +85°C for all new DC/DC converter releases. For a nominal fee, (waived for large orders) we will calculate the predicted MTTF of any Burr-Brown DC/DC converter. Demonstrated MTTF is also available on selected models.

### RELIABILITY

Customers may also choose one of two additional levels of screening to meet specific requirements. Screening is available on most standard models. The advanced reliability program is designed to reduce infant mortality, rework, field failures, and equipment downtime. Screening processes are summarized on the following page.

**STANDARD MANUFACTURING PROCESS**

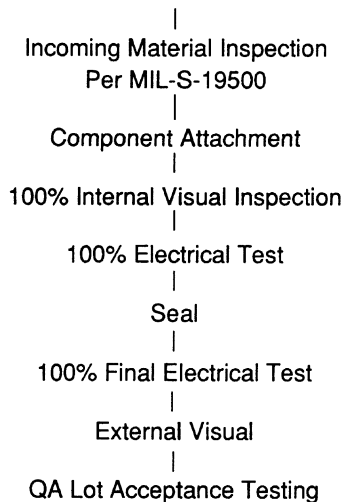

**/G-LEVEL I SCREENING**

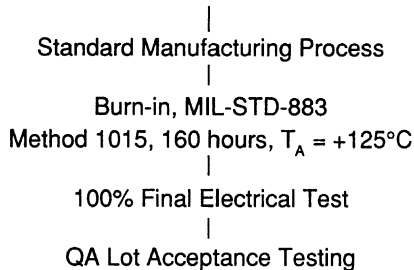

**/T-LEVEL II SCREENING**

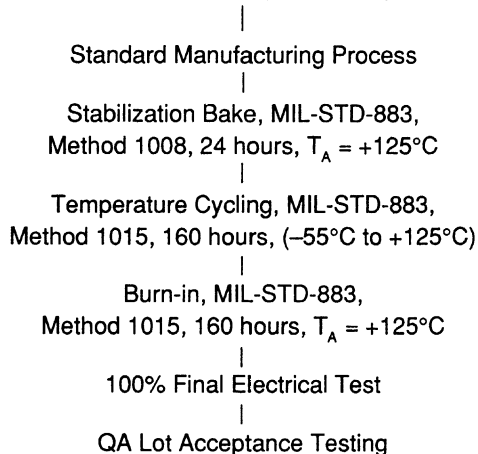



# POWER CONVERSION GLOSSARY

---

**Ambient Temperature**—The average temperature of the environment immediately surrounding the power supply.

**Breakdown Voltage**—The voltage level causing insulation failure.

**Cross-Regulation**—In a multiple output power supply, the percent voltage change at one output caused by the load change on another output.

**Crowbar**—An over-voltage protection circuit that rapidly places a low resistance shunt across the power supply output terminals if a predetermined voltage is exceeded.

**CSA**—Canadian Standards Association. An independent Canadian organization concerned with testing for public safety.

**Current Limiting**—An electronic overload protection circuit limiting the maximum output current to a preset value.

**Derating**—Practice of applying components or devices at a lower stress level than specified capabilities to reduce the occurrence of stress-related failures.

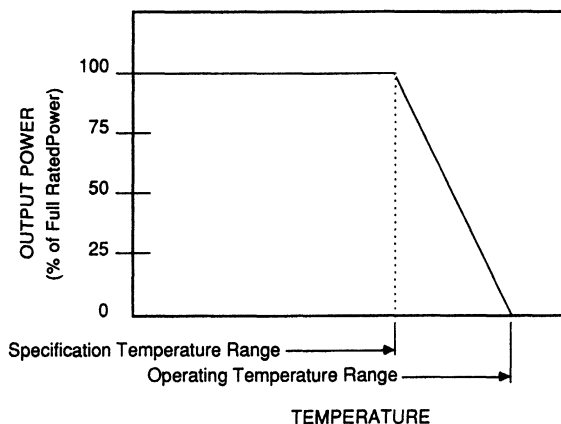

FIGURE 1. Derating Curve.

**Dielectric**—An insulating material between conductors.

**Dielectric Withstand Voltage**—The voltage an insulating material will withstand before flashover or puncture. See also *Hi-Pot Test, Isolation*.

**Drift**—A change in output over a period of time independent of input, environment, or load.

**Efficiency**—The ratio of the total output power to the total input power, expressed as a percentage, under specified conditions.

**Electromagnetic Interference (EMI)**—Any electronic disturbance that interrupts, obstructs, or otherwise impairs the performance of electronic equipment.

**EMI**—Abbreviation for Electromagnetic Interference.

**ESL**—Abbreviation for Equivalent Series Inductance.

**ESR**—Abbreviation for Equivalent Series Resistance.

**Equivalent Series Inductance (ESL)**—The amount of inductance in series with an ideal capacitor that exactly duplicates the performance of a real capacitor.

**Equivalent Series Resistance (ESR)**—The amount of resistance in series with an ideal capacitor that exactly duplicates the performance of a real capacitor.

**Faraday Shield**—An electrostatic shield between input and output windings of a transformer. This can be used to reduce coupling capacitance.

**Flyback Converter**—A power supply switching circuit that normally uses a single transistor. During the first half of the switching cycle, the transistor is on and energy is stored in a transformer primary. During the second half of the switching cycle, this energy is transferred to the transformer secondary and the load.

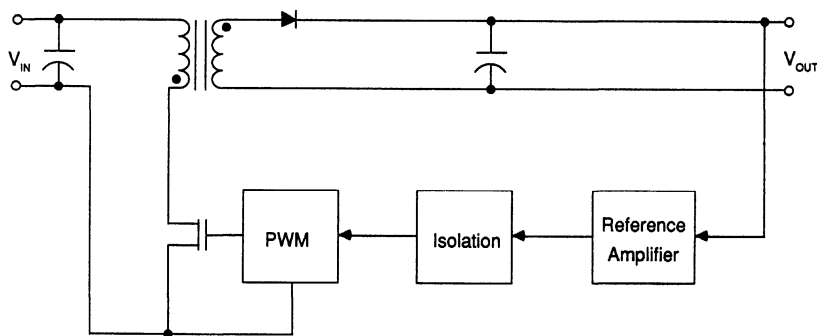

FIGURE 2. The Flyback Converter.

**Foldback Current Limiting**—A power supply output protection circuit whereby the output current decreases with increasing overload, reaching a minimum at short circuit. This minimizes internal power dissipation under overload conditions. Foldback current limiting is normally used with linear regulators.

**Forward Converter**—A power supply switching circuit that transfers energy to the transformer secondary when the switching transistor is on.

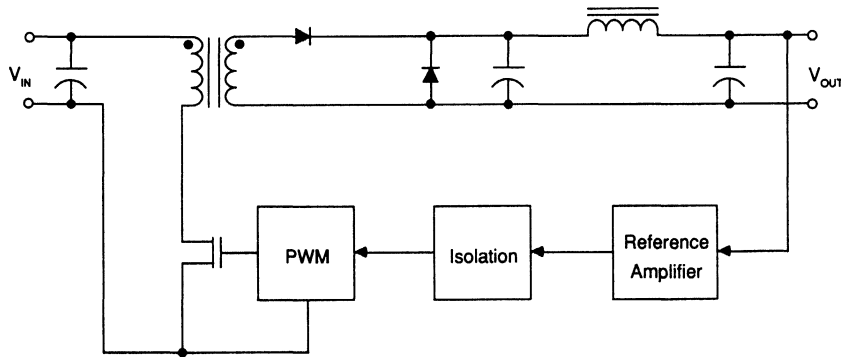

FIGURE 3. The Forward Converter (With Output PI Filter).

**Ground Loop**—A condition causing undesirable voltage levels when two or more circuits share a common electrical return or ground lines.

**Hi-Pot Test (High Potential Test)**—A test performed by applying a high voltage for a specified time to two isolated points in a device to determine adequacy of insulating materials.

**Input Line Filter**—A low-pass or band-reject filter at the input of a power supply that reduces line noise fed to the supply.

**Input PI Filter**—See *PI Filter*.

**Input Voltage Range**—The range of input voltage values for which a power supply or device operates within specified limits.

**Isolation Capacitance**—The capacitance across the isolation barrier.

**Isolation Resistance**—The resistance across the isolation barrier.

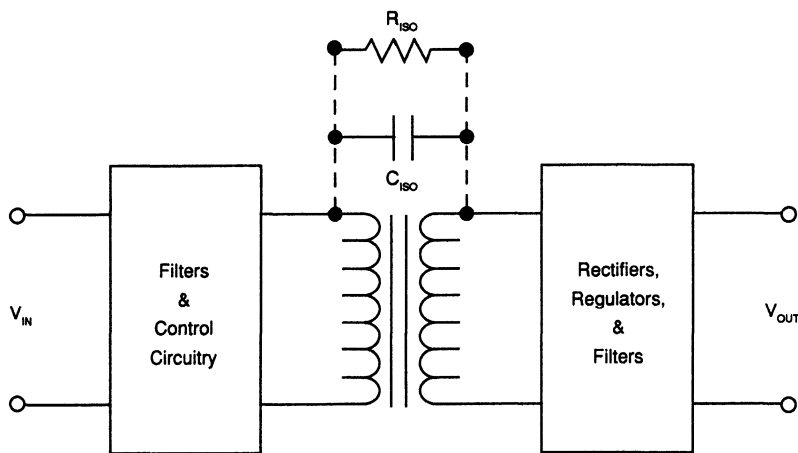

FIGURE 4. Isolation Resistance And Capacitance.

## Power Conversion Glossary

**Inverter**—A device that changes DC power into AC power.

**Isolation**—The electrical separation between two circuits, or circuit elements.

**Isolation Voltage**—The maximum AC or DC specified voltage that may be continuously applied between isolated circuits.

**Leakage Current**—The AC or DC current flowing from input to output and/or chassis of an isolated device at a specified voltage.

**Line Regulation**—The percentage change in output due to the input voltage varying over its specified limits, at specified load values, with all other factors constant.

**Linear Regulation**—A regulation technique wherein the control device, such as a transistor, is placed in series or parallel with the load.

**Load Decoupling**—The practice of placing filter components at the load to attenuate noise.

**Load Regulation**—1) Static: The change in output voltage as the load is changed from specified minimum load to maximum and maximum to minimum, with all other factors held constant.

2) Dynamic: The change in output voltage expressed as a percent for a given step change in load current. Initial and final current value and the rates of change must be specified.

**Logic Inhibit/Enable**—A referenced or isolated logic signal that turns a power supply output off or on.

**MTBF**—Abbreviation for Mean Time Between Failure.

**MTTF**—Abbreviation for Mean Time To Failure.

**Mean Time Between Failure**—The average length of time between system failures, exclusive of infant mortality and rated end-of-life. An established method of calculating MTBF is described in the most recent edition of MIL-HDBK-217.

**Mean Time To Failure**—The equivalent of MTBF for non-field-repairable units.

**No Load Voltage**—Terminal voltage of a supply when no current is flowing in external circuit.

**Noise**—The aperiodic random component on the power source output that is unrelated to source and switching frequency. Unless specified otherwise, noise is expressed in peak-to-peak units over a specified bandwidth. See *Ripple*.

**Nominal Value**—The stated or objective value of a quantity or component, which may not be the actual value measured.

**Operating Temperature Range**—The range of ambient, baseplate, or case temperatures through which a power supply is specified to operate safely.

**Output Filter**—One or more discreet components used to attenuate output ripple and noise.

**Output Ripple and Noise**—See *Periodic and Random Deviation*.

**Output Voltage Accuracy**—The tolerance in percent of the output voltage.

**Overload Protection**—A feature that senses and responds to current of power overload conditions.

**Over-voltage Crowbar**—See *Crowbar*.

**Over-Voltage Protection (OVP)**—A feature that senses and responds to a high voltage condition.

**PARD**—Abbreviation for Periodic and Random Deviation.

**Periodic and Random Deviation (PARD)**—The sum of all ripple and noise components measured over a specified bandwidth and stated, unless otherwise specified, in peak-to-peak values.

**PI Filter**—A filter consisting of two line-to-line capacitors and a series inductance in a  $\pi$  configuration used to attenuate noise and ripple.

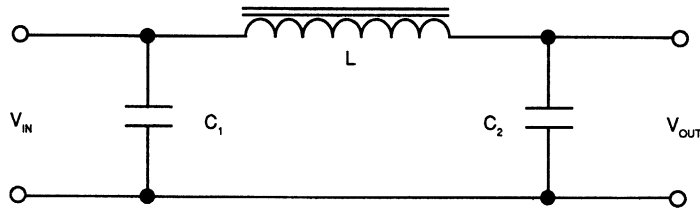

FIGURE 5. PI Filter.

**Post Regulation**—Refers to the use of a secondary regulator on a power supply output to improve line/load regulation and to attenuate ripple and noise.

**Preregulation**—The initial regulation circuit in a system containing at least two cascade regulation loops.

**PSMA**—Abbreviation for Power Sources Manufacturers Association.

**Pulse-Width Modulation**—A method of regulating the output voltage of a switching power supply by veering the duration, but not the frequency, of a train of pulses that drives a power switch.

**Push-Pull Converter**—A power switching circuit that uses two or more switches driven alternately on and off.

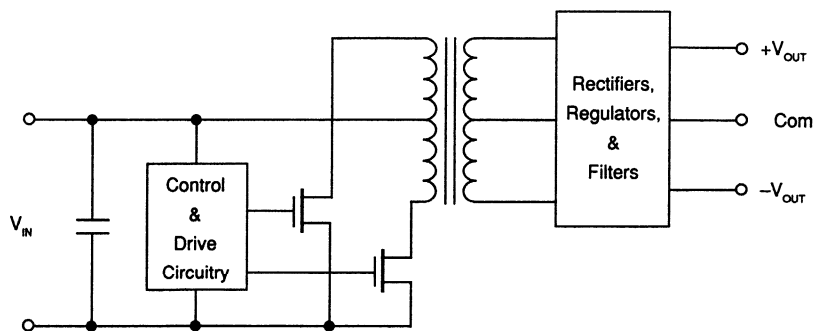

FIGURE 6. Push-Pull Converter.

**PWM**—Abbreviation for Pulse-Width-Modulation.

## Power Conversion Glossary

**Rated Output Current**—The continuous load current under which specifications of a power supply are determined.

**Reflected Ripple Current**—The AC current generated at the input of a power supply or DC/DC converter by the switching operation of the converter, stated as peak-to-peak or RMS.

**Return**—The name for the common terminal of the output of a power supply, it carries the return current for the outputs.

**Ripple**—The periodic component at the power source output harmonically related to source or switching frequencies. Unless specified otherwise, it is expressed in peak-to-peak units over a specified bandwidth.

**Short-Circuit Protection**—A protective feature limiting the output current of a power supply to prevent damage.

**Soft Start**—Controlled turn on to reduce in-rush current.

**Split Bobbin Winding**—The method of winding a transformer whereby the primary and secondary are wound side-by-side on a bobbin with an insulation barrier between the two windings.

**Stability**—The percent change in output parameter as a function of time, with all other factors held constant, following a specified warm-up period.

**Stand-By Current**—The input current drawn by a power supply under no load conditions.

**Switching Frequency**—The rate at which a DC voltage is switched in a converter.

**Temperature Coefficient**—The average percent change in output voltage per °C change in ambient temperature over a specified temperature range.

**Temperature Range, Specification**—The range of temperatures under which the power supply operates fully within all specifications.

**Temperature Range, Operating**—The range of temperatures under which it is safe to operate but one or more parameters might go out of specification.

**Temperature Range, Storage**—The range of temperatures through which an inoperative power supply can remain in storage without degrading its subsequent operation.

**Transformer**—Device that transfers energy from one circuit to another by means of electromagnetic induction.

**Transient Recovery Time**—The time required for the output voltage of a power supply to settle within specified output accuracy limits following a sudden change in line or load.

**UL**—Abbreviation for Underwriters Laboratories Incorporated.

**UPS**—Abbreviation for Uninterruptible Power Supply.

**VDE**—Abbreviation for *Verband Deutscher Elektotechniker*. A West German organization that tests equipment for public safety and emitted noise.

**Voltage Balance**—The difference in magnitude, in percent, between differential tracking output voltages of a power supply where the voltages have equal nominal values with opposite polarities.

**Warm-Up Drift**—The change in output voltage of a power source from turn-on until it reaches thermal equilibrium at specified operating conditions.

# APPLICATION NOTES

---

## TESTING ISOLATION BARRIER CHARACTERISTICS

The insulation and spacing of most PWR products are tested to meet the dielectric withstand requirements of UL544, paragraph 31. Check each product data sheet for details of its isolation properties. A 60Hz essentially sinusoidal potential is applied between the primary and secondary for a period of one minute. The potential used for this test is twice the maximum rated voltage plus 1000V.

Dielectric withstand testing is intended to be done at the manufacturer's site only. This test should not be repeated. Exposing the dielectric material of the isolation barrier to repeated testing causes microscopic carbonizing of the dielectric, resulting in a weakened barrier. A low resistance path will eventually be created across the barrier.

## PRESERVING ISOLATION CHARACTERISTICS

If intrinsic safety is required, care should be taken in the layout and assembly of the printed circuit board (PCB) to avoid degrading the isolation barrier of the DC/DC converter. Precautionary measures include cleaning the PCB prior to installing the PWR product. Some products come with standoffs built into the packaging to ease the cleaning procedure after installation. If not, use non-conductive spacers to keep the DC/DC converter off the PCB. Clean regularly to insure no contaminants accumulate under the unit. Use an epoxy solder mask to isolate PCB conductive traces which must run under or close to the converter. Do not use conductive inks on the PCB under the unit; e.g. inks used in inspection stamps or component identification marking.

## OUTPUT POWER DISTRIBUTION

Figure 1 shows the recommended method of connecting multiple loads to the converter. Single point distribution prevents ground loops and interaction between parallel load circuits.

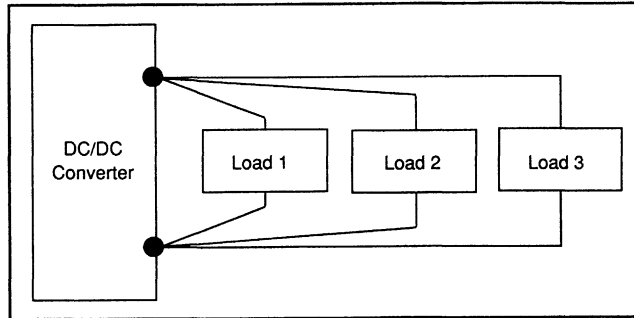

FIGURE 1. Recommended Power Distribution.

## LOW NOISE CONSIDERATIONS

Large ground planes are recommended because they serve as low inductance reference points for all components and increase the effectiveness of the shielding inside the DC/DC converter. The shield is usually attached to input common. If this is not a “quiet” reference, the shield, with its large physical area, could become a potential source of noise distortion. See the following two application notes for more information and application examples.



## DC-TO-DC CONVERTER NOISE REDUCTION

The inherent switching inside the DC-to-DC converter gives rise to potential sources of noise. This noise manifests itself on the output voltage as spikes at the switching frequency. Due to size and cost requirements, internal filtering is limited but usually adequate for most applications. When excessive noise is suspected, you must first rule out extraneous noise sources. Figure 1 illustrates the recommended method for testing output voltage ripple and noise.

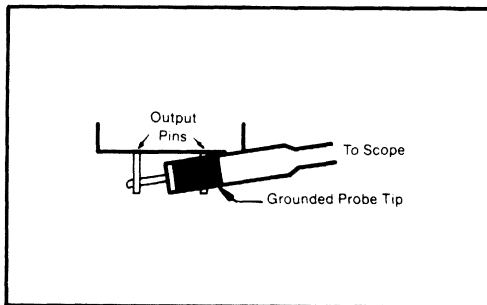

FIGURE 1. Recommended Noise Measurement Method.

If your circuit requires less noise than the supply is capable of, there are two preferred filter techniques—LC filters or an output filter capacitor.

### LC FILTERING

For applications requiring higher accuracy, such as analog measurements, LC filters should be used on each channel to attenuate high-frequency noise. Because of the output filter capacitor already present in the DC-to-DC converter, adding an inductor and capacitor to the output creates a pi filter at half the user-capacitor cost (Figure 2).

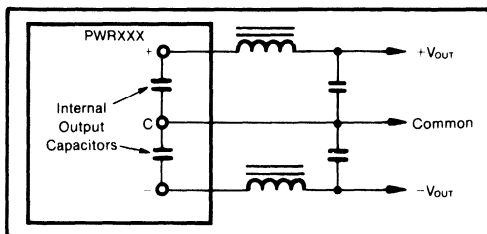

FIGURE 2. Output "PI" Filters.

It is important that the inductor wire size can carry the load current, including a safety factor, and that the core does not saturate. Also notice that the DC resistance of the inductor is outside the feedback loop for regulated units and subsequently degrades that regulation.

LC filters are generally used only where very accurate analog measurements are being taken, and the power supply rejection is poor at the ripple frequency. A much more common filtering technique is the output filter capacitor.

### CHOOSING AN OUTPUT CAPACITOR

The saying "the more the better" is definitely not applicable to output capacitors of switching type power supplies. The basic design equations of the supply rules out any brute force approach. The parameter of major concern is the Effective Series Resistance (ESR). ESR is due to stray resistance inside the electrolytic capacitor that becomes significant at switching power supply frequencies and higher. Together with Effective Series Inductance (ESL), ESR can be modeled as the equivalent circuit shown in Figure 3.

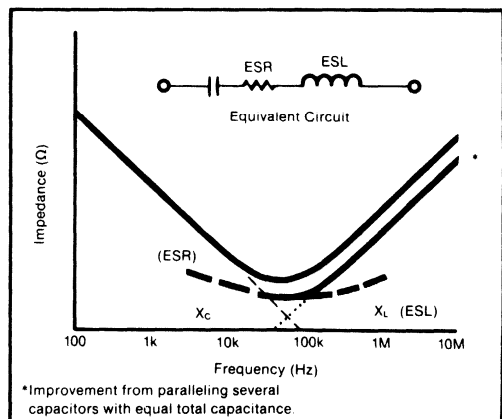

FIGURE 3. Typical Log/Log Impedance Plot for Aluminum Electrolytic Capacitor.

ESR is also a function of temperature and actually decreases as temperature is increased. This temperature dependency is particularly strong in the below zero range as shown in Figure 4. This, together with decreasing capacitance (Figure 5), can prove fatal to a switcher design that performed well on the bench.

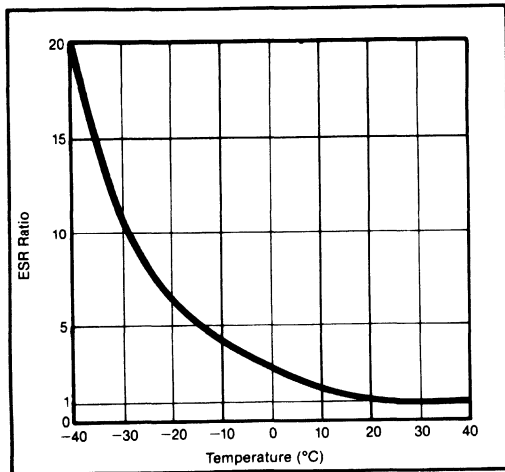

FIGURE 4. ESR Ratio Relative to Room Temperature.

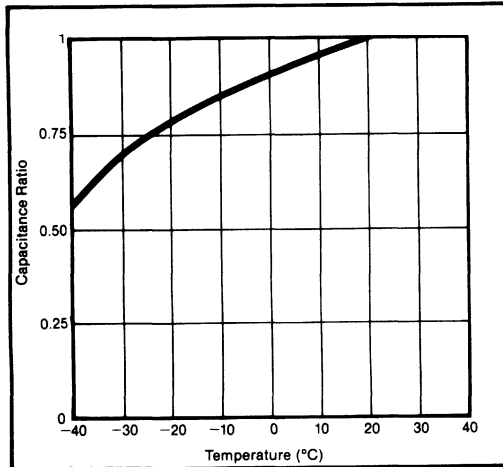

FIGURE 5. Capacitive Ratio Relative to Room Temperature.

The ESR becomes, in effect, a voltage divider with the internal output resistance of the supply. Therefore, the lower the ESR, the better suited the capacitor is for filtering the output of a switching type power supply. As the load increases, the capacitors' ripple current increase, causing a larger drop across the ESR, and consequently, a larger output ripple voltage (seen as noise). A commonly used method for estimating ESR is by means of the equation:

$$ESR = DF \times 0.01/2\pi fC$$

Where DF is given in %, f is given in hertz, and C is given in farads. Dissipation factor (DF) is a function of frequency and is useless if given at less than 1kHz. (If given at lower frequencies it is more indicative of equivalent parallel resistance). If given at 1kHz or greater, the above equation applies. Typical values are 8% to 24% at 1kHz for solid tantalums, and 0.1% to 3% at 1kHz for ceramics, and 8% at 120Hz for aluminum electrolytics. Most tantalum and aluminum electrolytic capacitor manufacturers do not specify the ESR, probably because it is not worth bragging about. One way of reducing ESR in design is to put two or more capacitors in parallel that add to the needed capacitance and reduce the ESR by the parallel resistance relation (see note in Figure 3). The second capacitor may be 1/10 or 1/100 the capacitance of the first, since it will provide bypassing for higher frequencies.

There are two basic families of electrolytic capacitors from which to choose: aluminum and tantalum. Aluminum types are available in many quality grades and fabrication techniques. Tantalum types come in foil, solid, and wet-slug subtypes. At first this may present a bewildering array of choices, but these can quickly be reduced by your particular need. Cheap aluminum electrolytics of questionable quality are often used but all too frequently this leads to actual noise generation, with poor reliability and in general, criticisms of high frequency switching type supplies. Good quality aluminum electrolytics probably provide the best compromise, if one must be made, between cost and performance. These are "computer grade" and other types made especially for switchers. Some have specialized construction that produce very low ESR and ESL rather than low cost. The outstanding feature of all tantalum types is their high capacitance to volume efficiency. This is particularly seen in the wet-slug tantalum, an undisputed winner in the capacitance versus volume contest. Solid tantalums appeal where there is a great emphasis on longevity, both shelf life and operating life. The foil-type tantalum is a very good capacitor for switchers but is not cost competitive with aluminum types. Where switching frequencies are very high (1MHz and greater) and current demands are low, nonelectrolytic capacitors will probably replace the previously discussed electrolytics, providing bypassing at high frequencies where the ESL of electrolytics becomes too high.

In addition to considering the capacitance, ESR, ESL, and appropriate voltage derating for the application, most capacitors have a maximum rms ripple current (or max rms ripple voltage) rating which should not be exceeded. Ripple current can be estimated by  $i_{rms} = i_{p-p}/3.5$  (or  $V_{rms} = V_{p-p}/3.0$ ). These ratings are too often ignored, but the stress produced by exceeded ripple will adversely effect the lifespan of the output filter capacitor.

The effect of ripple current flowing in the output capacitor is the dissipation of heat in the capacitor's ESR. Heat kills electrolytics in two ways—electrolytic depletion and electrolytic evaporation. The rate at which the electrolyte is lost depends on the electrolyte itself and the capacitor's internal structure. But whatever that rate, tests by aluminum capacitor makers indicate it nearly doubles for each 10°C rise in temperature. Thus, each 10°C rise nearly cuts the usable life of an aluminum capacitor in half. The best approach to counter this problem is to use capacitors designed and rated for higher temperatures.

Whatever capacitor is selected, its effective use depends greatly upon wiring techniques. For example, inductance can become dominant if good wiring practices are not followed and a low ESL requirement can be reduced through very careful wiring. Place the capacitor as close as possible to the load rather than the power supply. The reason for this is the presence of inductance in the wire or PCB trace and the existing output capacitor inside the supply. A small pi filter is formed furthering the reduction of noise. Capacitor lead length including circuit wiring on both sides of the capacitor should be minimized. Short, wide straps are the best and these can be paralleled for further reduction in self-inductance.

It's true that good capacitors have played a big role in making switching type power supplies a technological and commercial success, but this success has inspired the capacitor makers to devise even better suited types. Because of this impetus and the versatility of the switching power supply, it is difficult to say that one type of capacitor is inherently better than another. Most capacitor manufacturers are willing and able to provide advice that would help you in your decision.

**EXAMPLE: FILTERING THE PWR623**

The circuit in Figure 6, developed for and in use by a customer, is representative of the necessary considerations in filtering high frequency switching power supplies. In

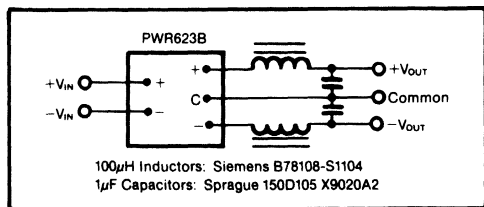

FIGURE 6. Filter Circuit for DC/DC Converter.

designing a filter to reduce the ripple and noise of the PWR623, an LC configuration was chosen to maximize ripple attenuation. The Siemens bobbin core was selected for its excellent current rating while the Sprague tantalum capacitor was selected for its relatively good ESR. The capacitor is also comparatively compact which lends it to use on printed circuit boards. In choosing values for the components, the calculated break (or 3dB) frequency should be significantly less than the ripple frequency. A first order analysis will contain several sources of error. These errors include the effects of loading, internal resistance, ESR of the inductor, and most importantly the ESR and ESL of the capacitor. In a first order analysis of an LC filter, the break frequency can be found by setting the inductive reactance equal to the capacitive reactance and solving for frequency (f).

$$2\pi fL = \frac{1}{2\pi fC}$$

$$f = \frac{1}{2\pi} \sqrt{\frac{1}{LC}}$$

For our example the inductor was 100µH and the capacitor was 1µF. This yielded a break frequency of 15.92kHz (Figure 7), which is an order of magnitude below the ripple frequency of the PWR6XX series (approximately 160kHz).

The PWR623 product data sheet shows a typical ripple of 30mVp-p. Upon bench testing the circuit (Figure 6) at rated load (±67mA), the noise was reduced to below the capabilities of the general test equipment being used.

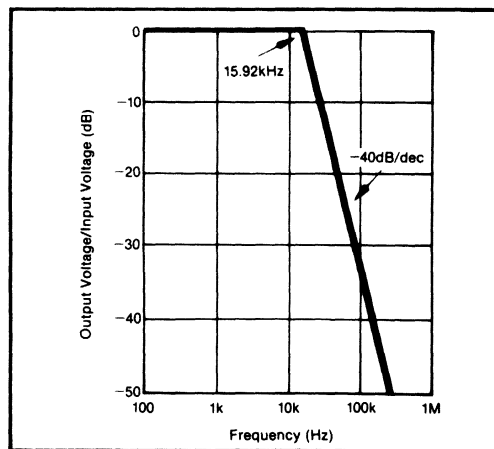

FIGURE 7. Linear First Order Approximation of Filter Circuit.

## MINIMIZING THE EFFECTS OF DC/DC CONVERTER SWITCHING NOISE

When dealing with high frequencies, the interaction between devices requires extreme care in setup. Some devices are more susceptible to high frequency noise. This unwanted interaction can ruin the performance of otherwise excellent devices. For our example we will look at the interaction between a DC-to-DC converter's high frequency noise and a wide band isolation amplifier. The DC to DC converter is the model PWR74 and the isolation amplifier is the ISO100.

At first, the use of DC/DC converters may seem trivial. You simply apply a DC voltage to the input and obtain one or more isolated DC voltages at the output. In practice though, things are not that simple. The switching action of the converter's internal circuitry can cause noise at its input, ripple at its output, and radiated interference into adjacent circuits.

All of these undesirable effects can be minimized by the techniques given in this application note. This example, developed for and in use by a customer, typifies the measures that can be taken to optimize practical DC/DC converter applications.

The following parts were used:

DC/DC converter	PWR74
Isolation amplifier	ISO100
L1-L5	100 $\mu$ H RF inductor
C1	10 $\mu$ F
C2-C5	1 $\mu$ F
C6-C9	.01 $\mu$ F
C10	5pF
R1, R2	1M $\Omega$
R4	2M $\Omega$
Z1, Z2	Offset voltage span.
R5, R6	Dimensioning as required.
R3/C11	Low-pass filter at output. Dimensioning as required.

### CIRCUIT

In order to be more universally applicable, this circuit (see Figure 1) was designed for three-port isolation. Thus the input from the power supply is isolated from both the input and output sides of the amplifier, which are isolated from each other. The circuit is configured with  $R1 = R2 = 1M\Omega$  providing unity gain. Selection of non-inverting unipolar or non-inverting bipolar mode is made through jumpers J1 and J2 as shown on the schematic. Setting jumper J3 provides offset adjustment through an auxiliary voltage stabilized with zener diodes.

To suppress any tendency toward oscillation, reduce peaking of frequency response, and limit output noise, the output stage is slightly compensated with  $C10 = 5pF$ . Ceramic bypassing capacitors were used for each supply voltage for both input and output sides directly at the IC. ( $C6 - C9 = .01\mu F$ ). Finally, the output voltage is available directly at output 1 or through a low-pass filter at output 2.

### PCB

Ground planes relating to the three isolation voltages are implemented on the component side of the PC board (see Figure 2). Each is separated by a space sufficient to assure high-voltage isolation. These planes offer low-inductance reference points required by RF applications and also provide guarding for sensitive signal lines. Leakage current across the PCB isolation barriers are minimized by guarding both rows of pins with low-resistance paths to their respective commons. This is done on the component as well as solder sides of the board.

### NOISE

If the input voltage to the DC/DC converter is not "clean", its effect on the amplifier will have to be minimized. Using the internal capacitor present in the PWR74, a pi filter was constructed with  $L1 = 100\mu H$  and  $C1 = 10\mu F$ . In addition, the filter suppresses the reflected ripple current of the DC/DC converter caused by the dynamic current component at its switching frequency (about 500kHz). This is of major importance if other circuits are supplied by the input voltage.

Each of the PWR74 output voltage ports contains an internal filter capacitor. An LC filter ( $L2 - L5 = 100\mu H$ ,  $C2 - C5 = 1\mu F$ ) was used for additional ripple suppression. The filtering of high frequency noise directly at its source not only eliminates conducted noise, but also simplifies circuit layout. The high frequency of the PWR74 demands low effective series resistance (ESR) capacitors for the input and output filters ( $C1 - C5$ ). For this reason ceramic caps were used.

The PWR74 internal shielding is connected to the  $-V_{IN}$  pin of the converter. This "quiet" ground, with respect to radio frequencies, is absolutely necessary for efficiency in shielding radiated noise. RF oscillations on the shield not only would jeopardize its desired effect, but also would become a potential source of distortion to other circuitry.

**OTHER APPLICATION CONSIDERATIONS**

1. For long input lines to the ISO100, use shielded or twisted pair cable.
2. The ISO100 Input Common (pin 18) and -In (pin 17) should be grounded through separate lines. The Input Common can carry large DC currents and may cause feedback to the signal input.
3. Care should be taken to minimize external capacitance across the isolation barrier.
4. Distance across the isolation barrier between external components and conductor patterns should be maximized to reduce leakage and arcing.
5. Use of conformally coated printed circuit boards is recommended.
6. When in the unipolar mode, the reference currents (pins 8 and 16) must be terminated.  $I_{IN}$  should be greater than 20nA to keep internal LED on.
7. The noise contribution of the reference currents will cause the bipolar mode to be noisier than the unipolar mode.
8. The maximum signal output voltage swing is determined by  $I_{IN}$  and RF.

$$V_{MAX SWING} = I_{IN MAX} \times RF$$

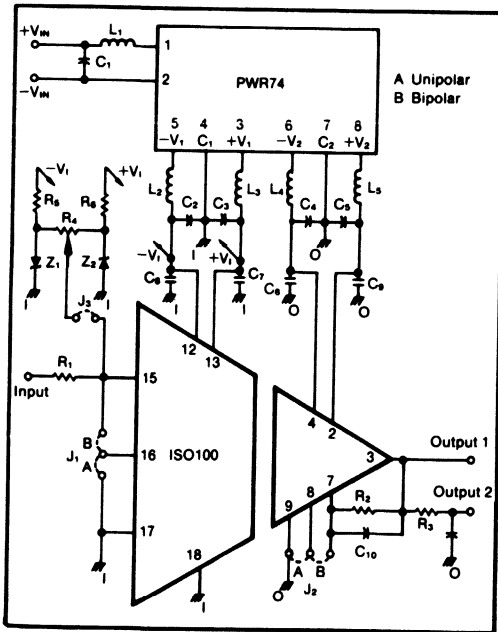

FIGURE 1. Example Circuit Diagram.

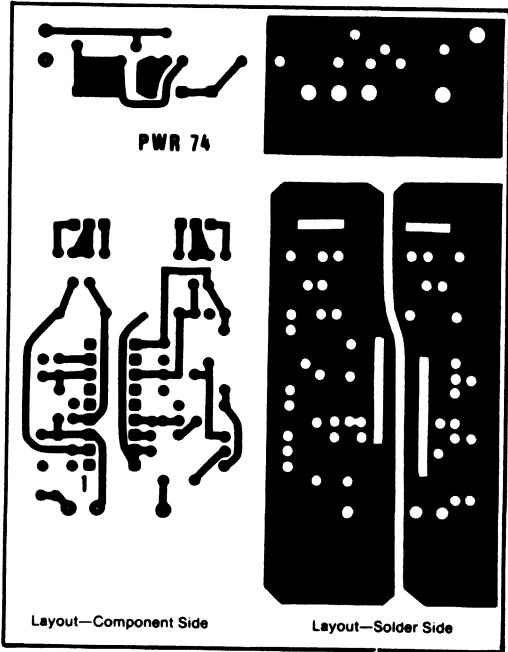

FIGURE 2. PCB Layout Diagrams.





PWR70

## ISOLATED DC/DC CONVERTER

### Low Cost—Unregulated Outputs

### OUTPUT POWER TO 3 WATTS

#### FEATURES

- TESTED IN COMPLIANCE WITH UL544
- OUTPUT POWER TO 3 WATTS
- HIGH ISOLATION VOLTAGE 2000V<sub>PEAK</sub>
- SIX-SIDED SHIELDING
- INPUT AND OUTPUT FILTERING
- LOW PROFILE PACKAGE 0.4" HIGH

#### APPLICATIONS

- SPOT REGULATOR
- POWER FOR DATA ACQUISITION, OP AMPS, ETC.
- PROCESS CONTROL
- PORTABLE EQUIPMENT
- TEST EQUIPMENT

#### DESCRIPTION

The PWR70 is a single-channel, dual-output DC/DC converter designed for general purpose power conversion applications where high efficiency is more important than load regulation.

The PWR70 provides a plus and minus output voltage approximately equal to the input voltage magnitude. It operates over an input voltage range of 10VDC to 18VDC. Isolation voltage is a minimum of 2000 V<sub>PK.</sub>

Six-sided shielding suppresses electromagnetic radiation which could disturb sensitive analog measurements or interfere with system timing signals. Input filtering minimizes reflected ripple current. Output ripple voltage and switching transients are reduced by filtering the PWR70 outputs.

The PWR70 is tested in compliance with UL544 dielectric withstand voltage requirements for primary circuits.

#### SIMPLIFIED CIRCUIT DIAGRAM

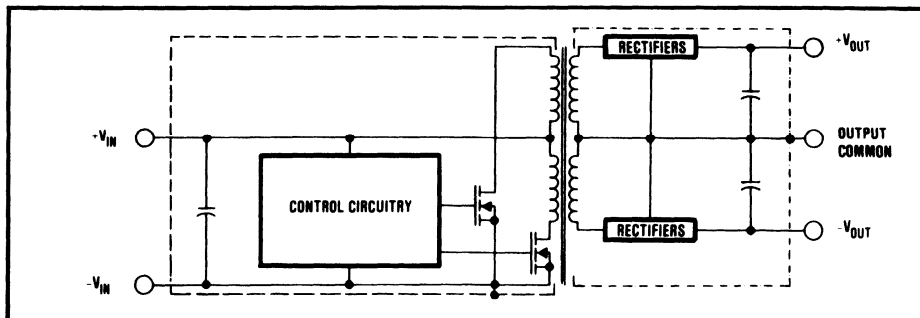

International Airport Industrial Park - P.O. Box 11400 - Tucson, Arizona 85734 - Tel. (602) 746-1111 - Twx: 910-952-1111 - Cable: BBRCORP - Telex: 66-6491

PDS-531B

# SPECIFICATIONS

## ELECTRICAL

At  $T_A = +25^\circ\text{C}$ ,  $V_{IN} = 15\text{VDC}$ , and  $I_{OUT} = \pm 15\text{mA}$  unless otherwise noted.

PARAMETER	CONDITIONS	MIN	TYP	MAX	UNITS
<b>INPUT</b>					
Rated Voltage			15		VDC
Voltage Range		10		18	VDC
Input Current	$I_{OUT} = \pm 3\text{mA}$		25		mA
Ripple Current	$I_{OUT} = \pm 33\text{mA}$			150	mA
	$I_{OUT} = \pm 3\text{mA}$		$\pm 10$		mA, pk
	$I_{OUT} = \pm 33\text{mA}$		$\pm 10$		mA, pk
<b>ISOLATION</b>					
Rated Voltage	60sec, 60Hz, 5000V pk	2000			VDC
Resistance			10G		$\Omega$
Capacitance			12		pF
Leakage Current	$V_{ISO} = 240\text{VAC}$ , 60Hz			2	$\mu\text{A}$
<b>OUTPUT</b>					
Rated Voltage			$\pm 15$		VDC
Voltage Accuracy				5	%
Rated Current			$\pm 15$		mA
Current Range		0		$\pm 100$	mA
Line Regulation	$10\text{VDC} \leq V_{IN} \leq 18\text{VDC}$		1.08		V/V
Load Regulation	$\pm 3\text{mA} \leq I_{OUT} \leq \pm 33\text{mA}$		35		mV/mA
Ripple Voltage	$I_{OUT} = \pm 3\text{mA}$		$\pm 10$		mV, pk
	$I_{OUT} = \pm 33\text{mA}$			$\pm 80$	mV, pk
<b>TEMPERATURE</b>					
Specification		-25		+85	$^\circ\text{C}$
Operating		-55		-125	$^\circ\text{C}$
Storage		-65		+150	$^\circ\text{C}$

## MECHANICAL

Pin numbers shown for reference only.

Bottom View

"\*" denotes missing pin.

NOTE: Input and Output circuits have separate shields.

DIM.	INCHES		MILLIMETERS	
	MIN	MAX	MIN	MAX
A	1.075	1.175	27.31	29.85
B	1.075	1.175	27.31	29.85
C	.360	.420	8.89	10.67
D	.038	.042	0.97	1.07
G	.200 BASIC		5.08 BASIC	
H	.212	.312	5.38	7.92
K	.170	.350	4.32	8.89
L	.800 BASIC		20.32 BASIC	
P	.100 BASIC		2.54 BASIC	
R	.112	.212	2.84	5.38

Material: Black Epoxy  
Weight: 15 gm. (0.53 oz.)  
Grid: 2.50mm (0.10")

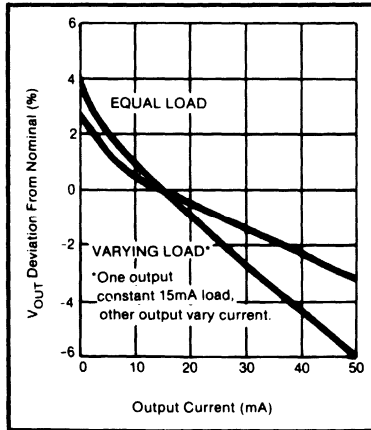

FIGURE 1. Load Regulation.

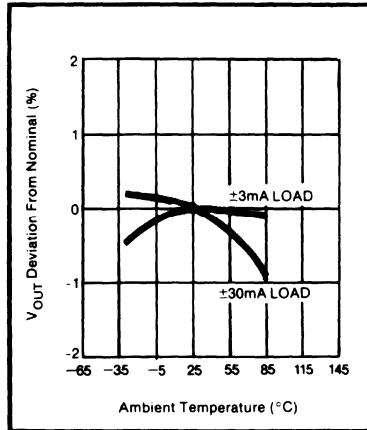

FIGURE 2. Temperature Drift.

### ABSOLUTE MAXIMUM RATINGS

Input Voltage	18VDC
Output Current	$\pm 150\text{mA}$
Output Short-Circuit Duration	Continuous

## CONNECTION DIAGRAM

NOTE: Input and output circuits have separate shields. Input shield is connected to  $-V_{IN}$ . Output shield is connected to output common.





PWR71

## ISOLATED DC/DC CONVERTER

### Four Isolated Channels - Dual, Unregulated Outputs

### 3 WATTS RATED OUTPUT POWER

#### FEATURES

- TESTED IN COMPLIANCE WITH UL544
- OUTPUT POWER TO 3 WATTS
- HIGH ISOLATION VOLTAGE 1000V<sub>PEAK</sub>
- SIX-SIDED SHIELDING
- INPUT AND OUTPUT FILTERING
- LOW PROFILE PACKAGE 0.4" HIGH

#### DESCRIPTION

The PWR71 is a four-channel, dual-output, unregulated DC/DC converter designed for general purpose power conversion applications where high efficiency is more important than load regulation.

The PWR71 has four isolated plus and minus output voltages approximately equal to the magnitude of the input voltage. It operates over an input voltage range of 10VDC to 18VDC. Rated output current for the PWR71 is 25mA per output or a total of 200mA for all outputs.

Isolation voltage between the input and any of the four output circuits is 1000V<sub>PK</sub> continuous. This same isolation specification applies between any of the four dual outputs.

#### APPLICATIONS

- SPOT REGULATOR
- POWER FOR DATA ACQUISITION, OP AMPS, ETC.
- PROCESS CONTROL
- PORTABLE EQUIPMENT
- TEST EQUIPMENT

A continuous connection between an output and its common will not damage the PWR71. Short circuit protection is accomplished by using power MOSFETs in the PWR71 input circuitry.

Six-sided shielding suppresses electromagnetic radiation which could disturb sensitive analog measurements or interfere with system timing signals. Filtering the PWR71 input and outputs minimizes the effects of electrical noise on the source and loads of the converter.

Each PWR71 is tested in compliance with UL544, VDE750, and CSA C22.2 dielectric withstand specifications. In addition, barrier leakage current is 100% tested.

# SPECIFICATIONS

## ELECTRICAL

At  $T_A = +25^\circ\text{C}$ ,  $+V_{IN} = 15\text{VDC}$ , and  $I_{OUT} = \pm 25\text{mA}$  unless otherwise noted.

PARAMETER	CONDITIONS	MIN	NOM	MAX	UNITS
<b>INPUT</b>					
Rated Voltage			15		VDC
Voltage Range		10		18	VDC
Input Current	$I_{LOAD} = 0$		50		mA
Ripple Current	$I_{LOAD} = \text{Rated Load}$		280		mA
	$I_{LOAD} = 0$		30		mA, pk
	$I_{LOAD} = \text{Rated Load}$		80		mA, p-p
<b>ISOLATION</b>					
Rated Voltage	60 sec, 60 Hz, 3000 $V_{PK}$	1000			VDC
Resistance			10G		$\Omega$
Capacitance			10		pF
Leakage Current	$V_{ISO} = 240\text{VAC}$ , 60Hz			3	$\mu\text{A}$
<b>OUTPUT</b>					
Rated Voltage	$I_{OUT} = \text{No Load}$	$\pm 15$	$\pm 15$	$\pm 18$	VDC
Voltage Range	$I_{OUT} = \text{Rated Load}$	$\pm 14.25$		$\pm 15.75$	VDC
Rated Power	Each output	$\pm 25$			Watts
Rated Current	Total of all outputs	200			mA
Current Range	Each output	0		$\pm 40$	mA
	Total of all outputs	0		500	mA
Line Regulation	$10\text{VDC} \geq V_{IN} \geq 18\text{VDC}$		1.08		mV/mA
Load Regulation	$0\text{mA} \geq I_{LOAD} \geq 25\text{mA}$		35		mV/mA
Ripple Voltage	$I_{LOAD} = 0$		$\pm 10$		mV, pk
	$I_{LOAD} = \text{Rated Load}$			$\pm 100$	mV, pk
<b>TEMPERATURE</b>					
Specification		-25		+85	$^\circ\text{C}$
Operating		-40		+100	$^\circ\text{C}$
Storage		-55		+125	$^\circ\text{C}$

## MECHANICAL

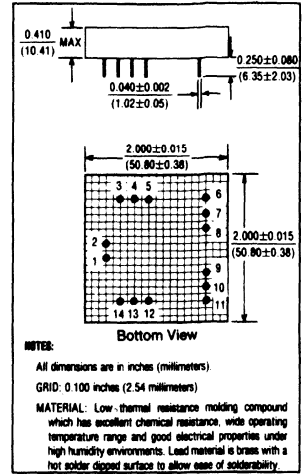

## ABSOLUTE MAXIMUM RATINGS

Input Voltage	18VDC
Output Current	500 mA
Output Short-Circuit	
Duration	Continuous

## TYPICAL PERFORMANCE CURVES

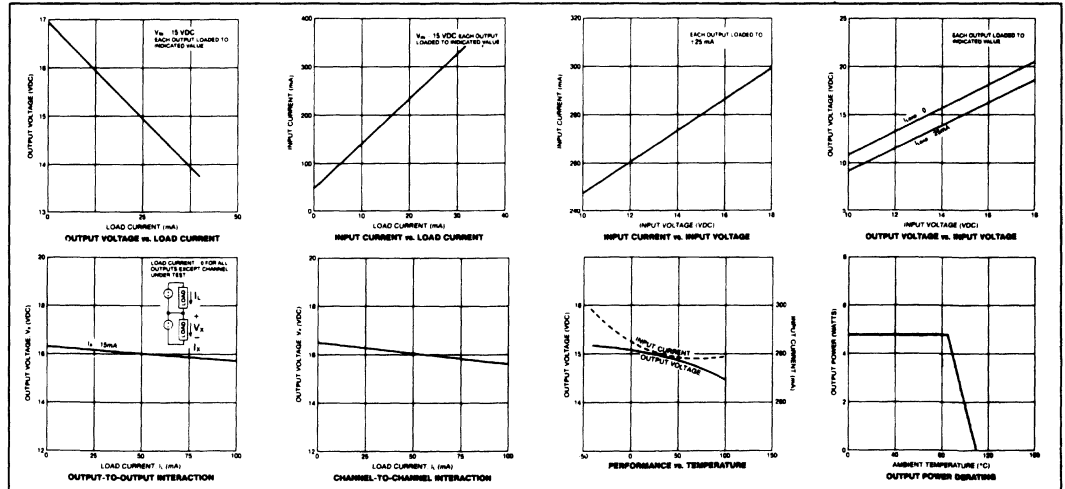

## TYPICAL APPLICATIONS

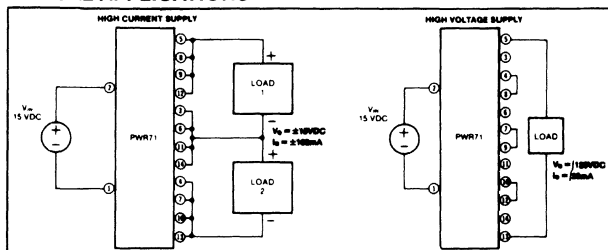

## CONNECTION DIAGRAM

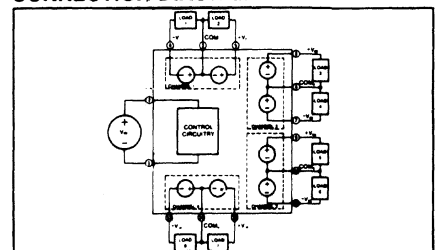



# PWR72

## Wide Input Voltage Range—5VDC to 22VDC UNREGULATED DC/DC CONVERTER

### FEATURES

- Low Price
- High Power Output: 3W, minimum
- Wide Input Voltage Range: 5VDC to 22VDC
- Isolation Barrier 100% Tested per UL544, VDE750, and CSA C22.2 Dielectric Withstand
- Isolation Barrier Leakage Current 100% Tested at 240VAC: 3 $\mu$ A, maximum
- Low Isolation Barrier Capacitance: 10pF
- Single-Channel, Dual Output

### DESCRIPTION

The PWR72 is a 3W, single-channel, dual-output DC/DC converter designed for low cost spot power conversion and ground elimination applications.

It provides a plus and minus output voltage approximately equal to the input voltage magnitude. The PWR72 operates over a wide range of input voltages from 5VDC to 22VDC. Its unregulated outputs give the PWR72 high efficiency power conversion.

Surface-mounted devices and manufacturing processes are used in the PWR72 to give the user a device which is more environmentally rugged than most DC/DC converters. The use of surface-mounted technologies also gives the PWR72 superior isolation voltage. A third advantage of using surface-mounted technologies is low manufacturing cost.

### CONNECTION DIAGRAM

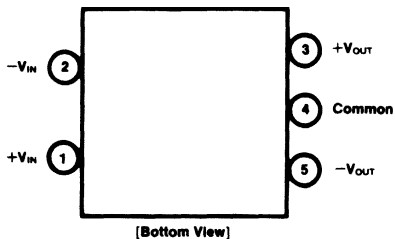

### ORDERING INFORMATION

PWR 72 /G

Device Family \_\_\_\_\_  
 PWR indicates DC/DC converter \_\_\_\_\_  
 Model Number \_\_\_\_\_

Reliability Screening  
 No designator indicates standard manufacturing processing  
 /G indicates Level I screening—burn-in only  
 /T indicates Level II screening—stabilization bake, temperature cycling, and burn-in

### TYPICAL APPLICATION

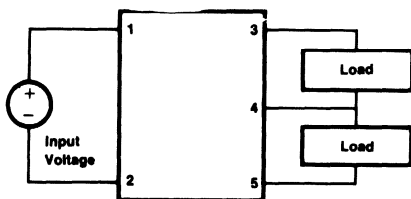

# SPECIFICATIONS

## ELECTRICAL

At  $T_A = +25^\circ\text{C}$ ,  $V_{IN} = 15\text{VDC}$ , and  $I_{OUT} = \pm 100\text{mA}$  unless otherwise noted.

Parameter	Conditions	Min	Typ	Max	Units
<b>INPUT</b>					
Rated Voltage			15	22	VDC
Voltage Range		5			VDC
Input Current	$I_{LOAD} = 0$		40		mA
	$I_{LOAD} = \text{Rated Load}$		280	330	mA
Ripple Current	$I_{LOAD} = 0$		15		mA, pk
	$I_{LOAD} = \text{Rated Load}$		150		mA, p-p
<b>ISOLATION</b>					
Rated Voltage		1000			VDC
Test Voltage	60sec, 60Hz	3000			$V_{PK}$
Resistance			10		$\Omega$
Capacitance			10		$\mu\text{F}$
Leakage Current	$V_{ISO} = 240\text{VAC}, 60\text{Hz}$			3	$\mu\text{A}$
<b>OUTPUT</b>					
Rated Voltage			$\pm 15$	$\pm 20$	VDC
Voltage Range	$I_{OUT} = \text{No Load}$	$\pm 15$			VDC
	$I_{OUT} = \text{Rated Load}$	$\pm 14.25$		$\pm 15.75$	VDC
Rated Power		3			W
Rated Current		100			mA
Current Range	Total of all outputs	200			mA
	Each output	0		$\pm 150$	mA
	Total of all outputs	0		300	mA
Line Regulation	$10\text{VDC} \geq V_{IN} \geq 18\text{VDC}$		1.15		V/V
Load Regulation	$0\text{mA} \geq I_{LOAD} \geq 100\text{mA}$		15		mV/mA
Ripple Voltage	$I_{LOAD} = 0$		30		mV, pk
	$I_{LOAD} = \text{Rated Load}$			150	mV, pk
<b>TEMPERATURE</b>					
Specification		-25		+85	$^\circ\text{C}$
Operation		-40		+100	$^\circ\text{C}$
Storage		-55		+125	$^\circ\text{C}$

## ABSOLUTE MAXIMUM RATINGS

Input Voltage	22VDC
Output Short-Circuit Duration	Momentary
Internal Power Dissipation	3W
Junction Temperature	+175 $^\circ\text{C}$
Package Thermal Resistance	13 $^\circ\text{C/W}$
Lead Temperature (soldering, 10 seconds)	+300 $^\circ\text{C}$

## MECHANICAL

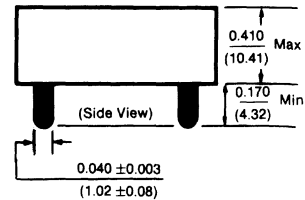
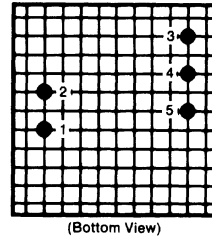
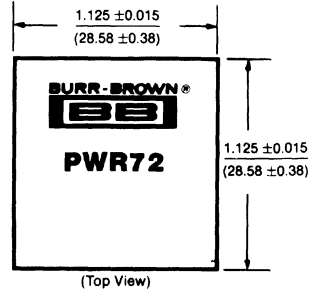

NOTES:  
 All dimensions are in inches (millimeters)  
 GRID: 0.100 inches (2.54 millimeters)  
 MATERIAL: Low thermal resistance molding compound which has excellent chemical resistance, wide operating temperature range and good electrical properties under high humidity environments. Lead material is brass with a hot-solder-dipped surface to allow ease of solderability.

OUTPUT VOLTAGE VS LOAD CURRENT

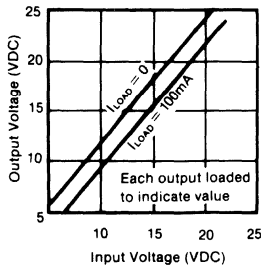
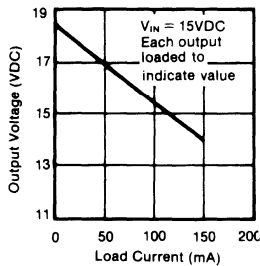

INPUT CURRENT VS LOAD CURRENT

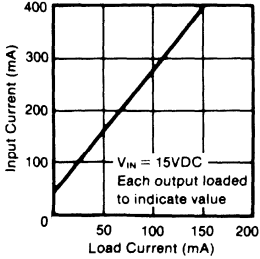

POWER DERATING

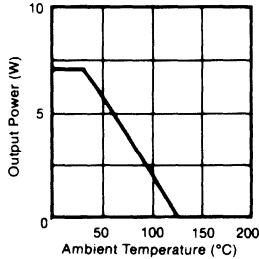



PWR74

## ISOLATED DC/DC CONVERTER

### Two Isolated Channels - Dual, Unregulated Outputs

### OUTPUT POWER TO 3 WATTS

#### FEATURES

- TESTED IN COMPLIANCE WITH UL544
- OUTPUT POWER TO 3 WATTS
- HIGH ISOLATION VOLTAGE 1500V<sub>PEAK</sub>
- SIX-SIDED SHIELDING
- INPUT AND OUTPUT FILTERING
- LOW PROFILE PACKAGE 0.4" HIGH

#### DESCRIPTION

The PWR74 is a two-channel, dual-output DC/DC converter designed for general purpose power conversion applications where high efficiency is more important than load regulation.

The PWR74 provides two isolated plus and minus output voltages approximately equal to the input voltage magnitude. It operates over an input voltage range of 10VDC to 20VDC. Isolation voltage is a minimum of 1500 V<sub>PK</sub>.

#### APPLICATIONS

- SPOT REGULATOR
- POWER FOR DATA ACQUISITION, OP AMPS, ETC.
- PROCESS CONTROL
- PORTABLE EQUIPMENT
- TEST EQUIPMENT

Six-sided shielding suppresses electromagnetic radiation which could disturb sensitive analog measurements or interfere with system timing signals. Input filtering minimizes reflected ripple current. Output ripple voltage and switching transients are reduced by filtering the PWR74 outputs.

Momentarily connecting an output pin to its output common will not damage the PWR74. Short-circuit protection is accomplished by using power MOSFETs in the PWR74's input circuitry.

The PWR74 is tested in compliance with UL544 dielectric withstand voltage requirements for primary circuits.

#### SIMPLIFIED CIRCUIT DIAGRAM

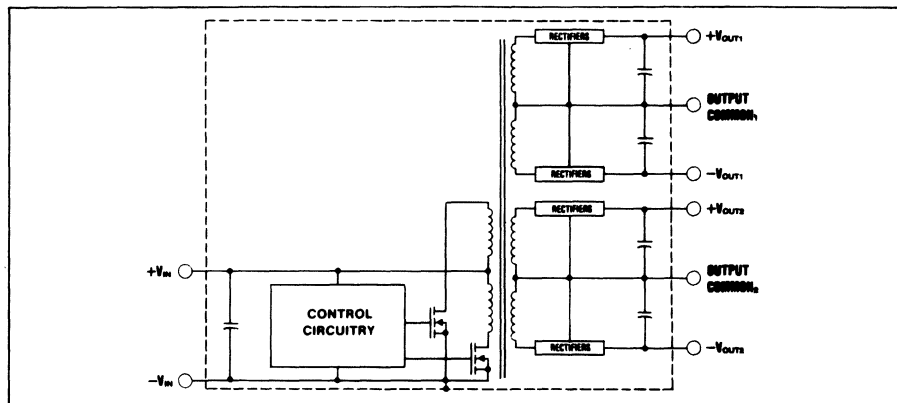

International Airport Industrial Park - P.O. Box 11400 - Tucson, Arizona 85734 - Tel (602) 746-1111 - Twx: 910-952-1111 - Cable: BBRCORP - Telex: 66-6491

PDS-561A

# SPECIFICATIONS

## ELECTRICAL

At  $T_A = +25^\circ\text{C}$ ,  $V_{IN} = 15\text{VDC}$ , and  $I_{OUT} = \pm 25\text{mA}$  unless otherwise noted.

PARAMETER	CONDITIONS	MIN	TYP	MAX	UNITS
<b>INPUT</b>					
Rated Voltage			15		VDC
Voltage Range		10		20	VDC
Input Current	$I_{OUT} = \text{No Load}$		55	75	mA
	$I_{OUT} = \text{Rated Load}$		155	175	mA
Ripple Current	$I_{OUT} = \text{No Load}$		80		mA, p.p.
	$I_{OUT} = \text{Rated Load}$		100		mA, p.p.
<b>ISOLATION</b>					
Rated Voltage <sup>(1)</sup>	60 sec, 60 Hz, 4000 $V_{PK}$	1500			$V_{PK}$
Resistance			10G		$\Omega$
Capacitance			12		pF
Leakage Current	$V_{ISO} = 240\text{VAC}$ , 60Hz			2	$\mu\text{A}$
<b>OUTPUT</b>					
Rated Voltage	$-25^\circ\text{C} \leq T_A \leq +85^\circ\text{C}$		$\pm 15$		VDC
Voltage Accuracy	$-25^\circ\text{C} \leq T_A \leq +85^\circ\text{C}$			5	%
Rated Current			$\pm 25$		mA
Current Range		0		$\pm 50$	mA
Line Regulation	$10\text{VDC} \leq V_{IN} \leq 20\text{VDC}$		1.15		V/V
Load Regulation	$\pm 5\text{mA} \leq I_{OUT} \leq \pm 25\text{mA}$		18		mV/mA
Ripple Voltage	$I_{OUT} = \text{No Load}$		20		mV, p.p.
	$I_{OUT} = \text{Rated Load}$		40	100	mV, p.p.
<b>TEMPERATURE</b>					
Specification		-25		+85	$^\circ\text{C}$
Operating		-55		+125	$^\circ\text{C}$
Storage		-65		+150	$^\circ\text{C}$

NOTE: 1) Ratings apply input-to-input and are typical channel-to-channel.

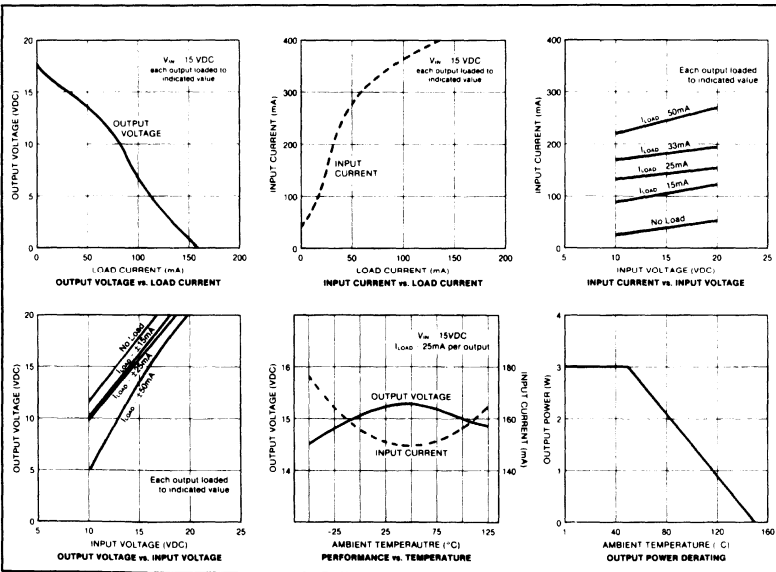

### ABSOLUTE MAXIMUM RATINGS

Input Voltage	..... 20VDC
Output Current	..... $\pm 100\text{mA}$
Output Short-Circuit Duration	..... 45 Seconds

## MECHANICAL

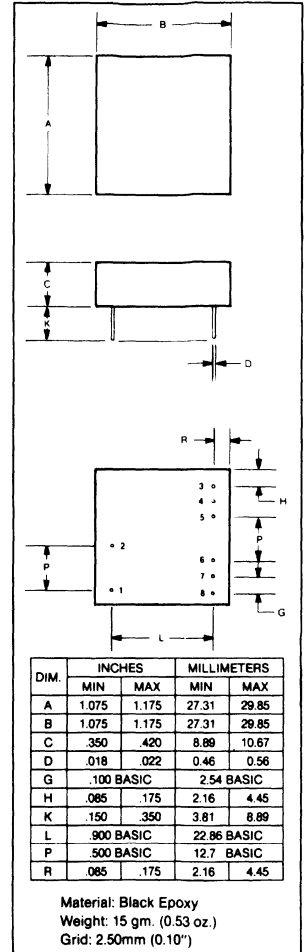

## CONNECTION DIAGRAM

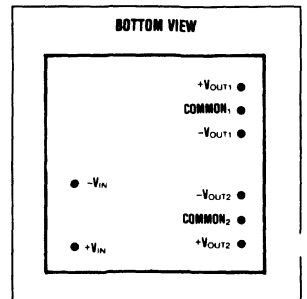



# PWR1XX Series

## 450mW Rated Output Power UNREGULATED DC/DC CONVERTER SERIES

### FEATURES

- Isolation Voltage Tested per UL544, VDE750, and CSAC22.2 Dielectric Withstand Requirement
- Barrier Leakage Current 100% Tested at 240VAC
- Single Channel
- Single or Dual Unregulated Outputs
- Wide Operating Temperature Range:  $-40^{\circ}\text{C}$  to  $+100^{\circ}\text{C}$
- Input and Output Filtering
- Six-Sided Shielding

### DESCRIPTION

The PWR1XX Series offers a large selection of unregulated 450mW DC/DC converters for use in

such diverse applications as process control, telecommunications, portable equipment, medical systems, airborne and shipboard electronic circuits, and automatic test equipment.

Thirty-six models allow the user to select input voltages ranging from +5VDC to +48VDC and output voltages of +5, +12, +15,  $\pm 5$ ,  $\pm 12$ , or  $\pm 15\text{V}$ .

Surface-mounted devices and manufacturing processes are used in the PWR1XX Series to give the user a device which is more environmentally rugged than most DC/DC converters. The use of surface-mount technologies also gives the PWR1XX Series superior isolation voltage. Each PWR1XX Series unit is tested in compliance with the dielectric withstand voltage requirements of UL544, VDE750, and CSAC22.2.

### CONNECTION DIAGRAM

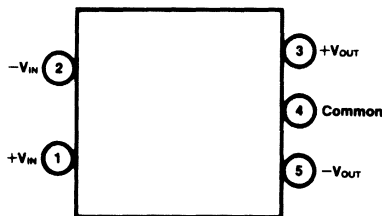

### ORDERING INFORMATION

Device Family \_\_\_\_\_ PWR 1XX /G  
 PWR indicates DC/DC converter  
 Model Number \_\_\_\_\_  
 Selected from table of Electrical Characteristics  
 Reliability Screening \_\_\_\_\_  
 No designator indicates standard manufacturing processing  
 /G indicates Level I screening—burn-in only  
 /T indicates Level II screening—stabilization bake, temperature cycling, and burn-in

### TYPICAL APPLICATIONS

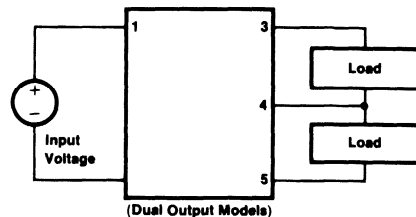
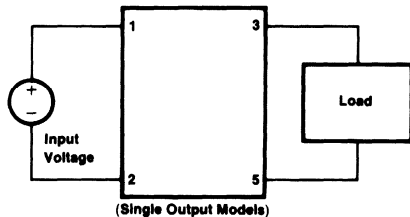

# SPECIFICATIONS

## ELECTRICAL CHARACTERISTICS<sup>(1)</sup>

Model	Nominal Input Voltage (VDC)	Rated Output Voltage (VDC)	Rated Output Current (mA)	Maximum Input Current (mA)
PWR100	5	5	90	180
PWR101		12	38	180
PWR102		15	30	180
PWR103		±5	±45	180
PWR104		±12	±19	180
PWR105	±15	±15	180	
PWR106	12	5	90	75
PWR107		12	38	75
PWR108		15	30	75
PWR109		±5	±45	75
PWR110		±12	±19	75
PWR111	±15	±15	75	
PWR112	15	5	90	60
PWR113		12	38	60
PWR114		15	30	60
PWR115		±5	±45	60
PWR116		±12	±19	60
PWR117	±15	±15	60	
PWR118	24	5	90	40
PWR119		12	38	40
PWR120		15	30	40
PWR121		±5	±45	40
PWR122		±12	±19	40
PWR123	±15	±15	40	
PWR124	28	5	90	35
PWR125		12	38	35
PWR126		15	30	35
PWR127		±5	±45	35
PWR128		±12	±19	35
PWR129	±15	±15	35	
PWR130	48	5	90	20
PWR131		12	38	20
PWR132		15	30	20
PWR133		±5	±45	20
PWR134		±12	±19	20
PWR135	±15	±15	20	

## COMMON SPECIFICATIONS<sup>(1)</sup>

Parameter	Conditions	Min	Typ	Max	Units
<b>INPUT</b>					
Voltage Range		±20% of Rated Input			
Input Ripple Current	I <sub>LOAD</sub> = Rated Load		30		mA, p-p
<b>ISOLATION</b>					
Rated Voltage		1000			VDC
Test Voltage	60Hz, 60 seconds	3000			V <sub>PK</sub>
Resistance			10		Ω
Capacitance			25		pF
Leakage Current	V <sub>ISO</sub> = 240VAC			5	μA
<b>OUTPUT</b>					
Voltage Accuracy	I <sub>LOAD</sub> = Rated Load			±5	%
Voltage (No Load)	V <sub>OUT</sub> = 5 Models			7	VDC
	V <sub>OUT</sub> = 12 Models			15	VDC
	V <sub>OUT</sub> = 15 Models			18	VDC
Ripple Voltage	I <sub>LOAD</sub> = Rated Load		50		mV, p-p
Line Regulation			1		%%
<b>TEMPERATURE</b>					
Specification		-25		+85	°C
Operation		-40		+100	°C
Storage		-55		+125	°C

NOTE: (1) Specifications typical at T<sub>a</sub> = +25°C, nominal input voltage, and rated output current unless otherwise noted.

## ABSOLUTE MAXIMUM RATINGS

Input Voltage	120% × Rated voltage
Output Short-Circuit Duration	Continuous to output common
Internal Power Dissipation	1W
Junction Temperature	+175°C
Package Thermal Resistance	90°C/W
Lead Temperature (soldering, 10 seconds)	+300°C

## MECHANICAL

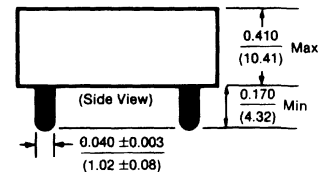
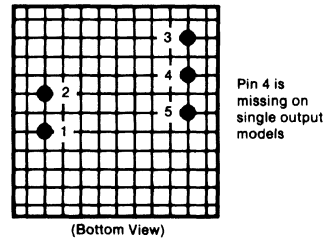
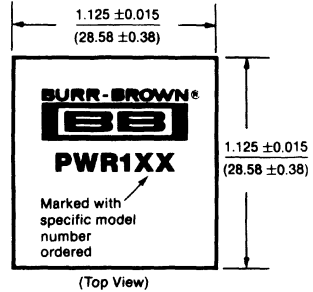

### NOTES:

All dimensions are in inches (millimeters)

GRID: 0.100 inches (2.54 millimeters)

**MATERIAL:** Low thermal resistance molding compound which has excellent chemical resistance, wide operating temperature range and good electrical properties under high humidity environments. Lead material is brass with a hot-solder-dipped surface to allow ease of solderability.





# PWR2XX Series

## 1.5 Watts Rated Output Power UNREGULATED DC/DC CONVERTER SERIES

### FEATURES

- Isolation Voltage Tested per UL544, VDE750, and CSAC22.2 Dielectric Withstand Requirement
- Barrier Leakage Current 100% Tested at 240VAC
- Single Channel
- Single or Dual Unregulated Outputs
- Wide Operating Temperature Range:  $-40^{\circ}\text{C}$  to  $+100^{\circ}\text{C}$
- Input and Output Filtering
- Six-Sided Shielding

### DESCRIPTION

The PWR2XX Series offers a large selection of unregulated 1.5W DC/DC converters for use in such

diverse applications as process control, telecommunications, portable equipment, medical systems, airborne and shipboard electronic circuits, and automatic test equipment.

Thirty-six models allow the user to select input voltages ranging from +5VDC to +48VDC and output voltages of +5, +12, +15,  $\pm 5$ ,  $\pm 12$ , or  $\pm 15$ VDC.

Surface-mounted devices and manufacturing processes are used in the PWR2XX Series to give the user a device which is more environmentally rugged than most DC/DC converters. The use of surface-mount technologies also gives the PWR2XX Series superior isolation voltage. Each PWR2XX Series unit is tested in compliance with the dielectric withstand voltage requirements of UL544, VDE750, and CSAC22.2.

### CONNECTION DIAGRAM

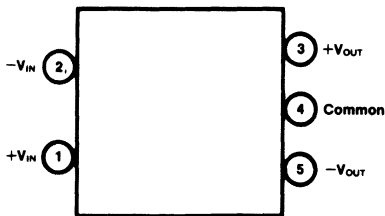

### ORDERING INFORMATION

Device Family \_\_\_\_\_ PWR 2XX / G  
 PWR indicates DC/DC converter  
 Model Number \_\_\_\_\_  
 Selected from table of Electrical Characteristics  
 Reliability Screening \_\_\_\_\_  
 No designator indicates standard manufacturing processing  
 /G indicates Level I screening—burn-in only  
 /T indicates Level II screening—stabilization bake, temperature cycling, and burn-in

### TYPICAL APPLICATIONS

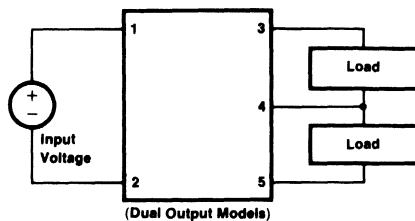
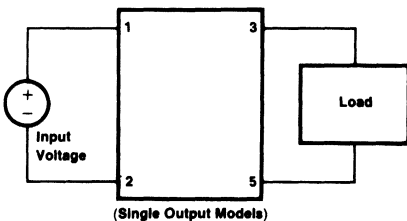

# SPECIFICATIONS

## ELECTRICAL CHARACTERISTICS<sup>(1)</sup>

Model	Nominal Input Voltage (VDC)	Rated Output Voltage (VDC)	Rated Output Current (mA)	Maximum Input Current (mA)
PWR200	5	5	300	545
PWR201		12	125	545
PWR202		15	100	545
PWR203		±5	±150	545
PWR204		±12	±63	545
PWR205	±15	±50	545	
PWR206	12	5	300	208
PWR207		12	125	208
PWR208		15	100	208
PWR209		±5	±150	208
PWR210		±12	±63	208
PWR211	±15	±50	208	
PWR212	15	5	300	167
PWR213		12	125	167
PWR214		15	100	167
PWR215		±5	±150	167
PWR216		±12	±63	167
PWR217	±15	±50	167	
PWR218	24	5	300	104
PWR219		12	125	104
PWR220		15	100	104
PWR221		±5	±150	104
PWR222		±12	±63	104
PWR223	±15	±50	104	
PWR224	28	5	300	92
PWR225		12	125	92
PWR226		15	100	92
PWR227		±5	±150	92
PWR228		±12	±63	92
PWR229	±15	±50	92	
PWR230	48	5	300	63
PWR231		12	125	63
PWR232		15	100	63
PWR233		±5	±150	63
PWR234		±12	±63	63
PWR235	±15	±50	63	

## COMMON SPECIFICATIONS<sup>(1)</sup>

Parameter	Conditions	Min	Typ	Max	Units
<b>INPUT</b>					
Voltage Range		±20% of Rated Input			
Input Ripple Current	I <sub>LOAD</sub> = Rated Load		50		mA, p-p
<b>ISOLATION</b>					
Rated Voltage		1000			VDC
Test Voltage	60Hz, 60 seconds	3000			V <sub>PK</sub>
Resistance			10		GΩ
Capacitance			25		pF
Leakage Current	V <sub>ISO</sub> = 240VAC			5	μA
<b>OUTPUT</b>					
Voltage Accuracy	I <sub>LOAD</sub> = Rated Load			±5	%
Voltage (No Load)	V <sub>OUT</sub> = 5V Models			7	VDC
	V <sub>OUT</sub> = 12V Models			15	VDC
	V <sub>OUT</sub> = 15V Models			18	VDC
Ripple Voltage	I <sub>LOAD</sub> = Rated Load		75		mV, p-p
Line Regulation			1		%/%
<b>TEMPERATURE</b>					
Specification		-25		+85	°C
Operation		-40		+100	°C
Storage		-55		+125	°C

NOTE: (1) Specifications typical at T<sub>A</sub> = +25°C, nominal input voltage, and rated output current unless otherwise noted.

## ABSOLUTE MAXIMUM RATINGS

Input Voltage	120% × rated voltage
Output Short-Circuit Duration	Continuous to output common
Internal Power Dissipation	2W
Junction Temperature	+175°C
Package Thermal Resistance	60°C/W
Lead Temperature (soldering, 10 seconds)	+300°C

## MECHANICAL

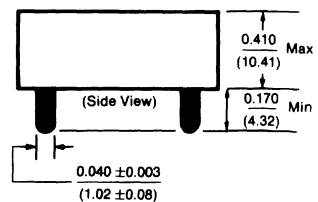
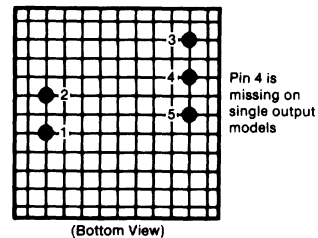
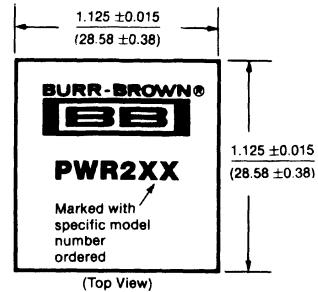

### NOTES:

All dimensions are in inches (millimeters)

GRID: 0.100 inches (2.54 millimeters)

**MATERIAL:** Low thermal resistance molding compound which has excellent chemical resistance, wide operating temperature range and good electrical properties under high humidity environments. Lead material is brass with a hot-solder-dipped surface to allow ease of solderability.



# PWR3XX Series

## Dual-Channel, 2 Watts Rated Output Power UNREGULATED DC/DC CONVERTER SERIES

### FEATURES

- Isolation Voltage Tested per UL544, VDE750, and CSAC22.2 Dielectric Withstand Requirement
- Barrier Leakage Current 100% Tested at 240VAC
- Single Channel
- Single or Dual Unregulated Outputs
- Wide Operating Temperature Range:  $-40^{\circ}\text{C}$  to  $+100^{\circ}\text{C}$
- Input and Output Filtering
- Six-Sided Shielding

### DESCRIPTION

The PWR3XX Series offers a large selection of unregulated 2W DC/DC converters for use in such

diverse applications as process control, telecommunications, portable equipment, medical systems, airborne and shipboard electronic circuits, and automatic test equipment.

Thirty-six models allow the user to select input voltages ranging from +5VDC to +48VDC and output voltages of +5, +12, +15,  $\pm 5$ ,  $\pm 12$ , or  $\pm 15$ VDC.

Surface-mounted devices and manufacturing processes are used in the PWR3XX Series to give the user a device which is more environmentally rugged than most DC/DC converters. The use of surface-mount technologies also gives the PWR3XX Series superior isolation voltage. Each PWR3XX Series unit is tested in compliance with the dielectric withstand voltage requirements of UL544, VDE750, and CSAC22.2.

#### CONNECTION DIAGRAM

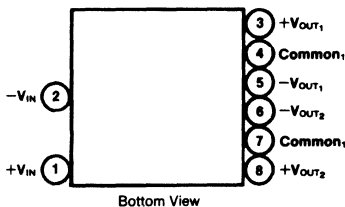

#### ORDERING INFORMATION

PWR 3XX /G

Device Family \_\_\_\_\_

PWR indicates DC/DC converter

Model Number \_\_\_\_\_

Selected from table of Electrical Characteristics \_\_\_\_\_

Reliability Screening

No designator indicates standard manufacturing processing

/G indicates Level I screening—burn-in only

/T indicates Level II screening—stabilization bake, temperature cycling, and burn-in

#### TYPICAL APPLICATIONS

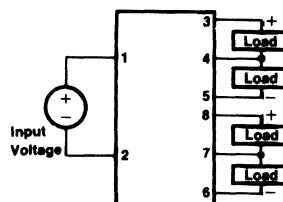

(Dual-Channel, Dual Output)

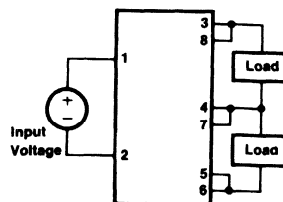

(Single-Channel, High-Current Dual Output)

# SPECIFICATIONS

## ELECTRICAL CHARACTERISTICS<sup>(1)</sup>

Model	Nominal Input Voltage (VDC)	Rated Output Voltage (VDC)	Rated Output Current (mA)	Maximum Input Current (mA)
PWR300	5	5	200	690
PWR301		12	84	690
PWR302		15	67	690
PWR303		±5	±100	690
PWR304		±12	±42	690
PWR305	±15	±34	690	
PWR306	12	5	200	265
PWR307		12	84	265
PWR308		15	67	265
PWR309		±5	±100	265
PWR310		±12	±42	265
PWR311	±15	±34	265	
PWR312	15	5	200	205
PWR313		12	84	205
PWR314		15	67	205
PWR315		±5	±100	205
PWR316		±12	±42	205
PWR317		±15	±34	205
PWR318	24	5	200	130
PWR319		12	84	130
PWR320		15	67	130
PWR321		±5	±100	130
PWR322		±12	±42	130
PWR323		±15	±34	130
PWR324	28	5	200	115
PWR325		12	84	115
PWR326		15	67	115
PWR327		±5	±100	115
PWR328		±12	±42	115
PWR329		±15	±34	115
PWR330	48	5	200	70
PWR331		12	84	70
PWR332		15	67	70
PWR333		±5	±100	70
PWR334		±12	±42	70
PWR335		±15	±34	70

## COMMON SPECIFICATIONS<sup>(1)</sup>

Parameter	Conditions	Min	Typ	Max	Units
<b>INPUT</b>					
Voltage Range		±20% of Rated Input			
Input Ripple Current	I <sub>LOAD</sub> = Rated Load	30			mA, p-p
<b>ISOLATION</b>					
Rated Voltage		1000			VDC
Test Voltage	60Hz, 60 seconds	3000			V <sub>PEAK</sub>
Resistance			10		GΩ
Capacitance			25		pF
Leakage Current	V <sub>ISO</sub> = 240VAC			10	μA
<b>OUTPUT</b>					
Voltage Accuracy	I <sub>LOAD</sub> = Rated Load			±5	%
Voltage (No Load)	V <sub>OUT</sub> = 5V Models			7	VDC
	V <sub>OUT</sub> = 12V Models			15	VDC
	V <sub>OUT</sub> = 15V Models			18	VDC
Ripple Voltage	I <sub>LOAD</sub> = Rated Load		50		mV, p-p
Line Regulation			1		%/%
<b>TEMPERATURE</b>					
Specification		-25		+85	°C
Operation		-40		+100	°C
Storage		-55		+125	°C

NOTE: (1) Specifications typical at T<sub>A</sub> = +25°C, nominal input voltage, and rated output current unless otherwise noted.

## ABSOLUTE MAXIMUM RATINGS

Input Voltage	120% × rated voltage
Output Short-Circuit Duration	Continuous to Output Common
Internal Power Dissipation	2W
Junction Temperature	+175°C
Package Thermal Resistance	90°C/W
Lead Temperature (soldering, 10 seconds)	+300°C

## MECHANICAL

(Top View)

(Bottom View)

(Side View)

Notes:  
 All dimensions are in inches (millimeters)  
 GRID: 0.100 inches (2.54 millimeters)  
 MATERIAL: Low thermal resistance molding compound which has excellent chemical resistance, wide operating temperature range and good electrical properties under high humidity environments. Lead material is brass with a hot-solder-dipped surface to allow ease of solderability.



# PWR4XX Series

## 3 Watts Rated Output Power UNREGULATED DC/DC CONVERTER SERIES

### FEATURES

- Isolation Voltage Tested per UL544, VDE750, and CSAC22.2 Dielectric Withstand Requirement
- Barrier Leakage Current 100% Tested at 240VAC
- Single Channel
- Single or Dual Unregulated Outputs
- Wide Operating Temperature Range:  $-40^{\circ}\text{C}$  to  $+100^{\circ}\text{C}$
- Input and Output Filtering
- Six-Sided Shielding

### DESCRIPTION

The PWR4XX Series offers a large selection of unregulated 3W DC/DC converters for use in such

diverse applications as process control, telecommunications, portable equipment, medical systems, airborne and shipboard electronic circuits, and automatic test equipment.

Thirty-six models allow the user to select input voltages ranging from +5VDC to +48VDC and output voltages of +5, +12, +15,  $\pm 5$ ,  $\pm 12$ , or  $\pm 15\text{V}$ .

Surface-mounted devices and manufacturing processes are used in the PWR4XX Series to give the user a device which is more environmentally rugged than most DC/DC converters. The use of surface-mount technologies also gives the PWR4XX Series superior isolation voltage. Each PWR4XX Series unit is tested in compliance with the dielectric withstand voltage requirements of UL544, VDC750, and CSAC22.2.

### CONNECTION DIAGRAM

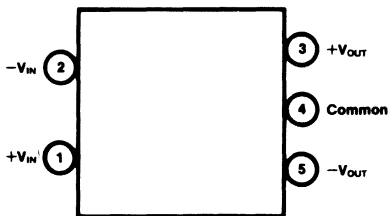

### ORDERING INFORMATION

Device Family \_\_\_\_\_ PWR 4XX / G  
 PWR indicates DC/DC converter  
 Model Number \_\_\_\_\_  
 Selected from table of Electrical Characteristics  
 Reliability Screening \_\_\_\_\_  
 No designator indicates standard manufacturing processing  
 /G indicates Level I screening—burn-in only  
 /T indicates Level II screening—stabilization bake, temperature cycling, and burn-in

### TYPICAL APPLICATIONS

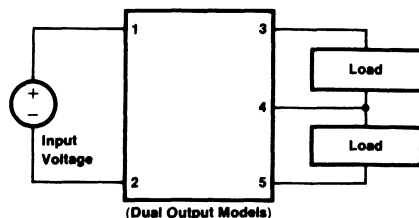
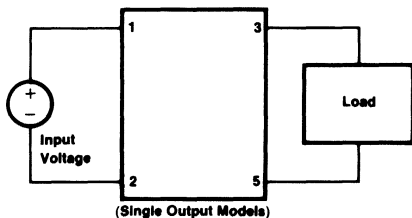

# SPECIFICATIONS

## ELECTRICAL CHARACTERISTICS<sup>(1)</sup>

Model	Nominal Input Voltage (VDC)	Rated Output Voltage (VDC)	Rated Output Current (mA)	Maximum Input Current (mA)
PWR400	5	5	600	1034
PWR401		12	250	1034
PWR402		15	200	1034
PWR403		±5	±300	1034
PWR404		±12	±125	1034
PWR405	±15	±100	1034	
PWR406	12	5	600	380
PWR407		12	250	380
PWR408		15	200	380
PWR409		±5	±300	380
PWR410		±12	±125	380
PWR411	±15	±100	380	
PWR412	15	5	600	286
PWR413		12	250	286
PWR414		15	200	286
PWR415		±5	±300	286
PWR416		±12	±125	286
PWR417	±15	±100	286	
PWR418	24	5	600	184
PWR419		12	250	184
PWR420		15	200	184
PWR421		±5	±300	184
PWR422		±12	±125	184
PWR423	±15	±100	184	
PWR424	28	5	600	162
PWR425		12	250	162
PWR426		15	200	162
PWR427		±5	±300	162
PWR428		±12	±125	162
PWR429	±15	±100	162	
PWR430	48	5	600	105
PWR431		12	250	105
PWR432		15	200	105
PWR433		±5	±300	105
PWR434		±12	±125	105
PWR435	±15	±100	105	

## COMMON SPECIFICATIONS<sup>(1)</sup>

Parameter	Conditions	Min	Typ	Max	Units
<b>INPUT</b>					
Voltage Range		±20% of Rated Input			
Input Ripple Current	I <sub>LOAD</sub> = Rated Load		70		mA, p-p
<b>ISOLATION</b>					
Rated Voltage		1000			VDC
Test Voltage	60Hz, 60 seconds	3000			V <sub>PEAK</sub>
Resistance			10		GΩ
Capacitance			50		pF
Leakage Current	V <sub>ISO</sub> = 240VAC			10	μA
<b>OUTPUT</b>					
Voltage Accuracy	I <sub>LOAD</sub> = Rated Load			±5	%
Voltage (No Load)	V <sub>OUT</sub> = 5V Models			7	VDC
	V <sub>OUT</sub> = 12V Models			15	VDC
	V <sub>OUT</sub> = 15V Models			18	VDC
Ripple Voltage	I <sub>LOAD</sub> = Rated Load		100		mV, p-p
Line Regulation			1		%/%
<b>TEMPERATURE</b>					
Specification		-25		+85	°C
Operation		-40		+100	°C
Storage		-55		+125	°C

NOTE: (1) Specifications typical at T<sub>A</sub> = +25°C, nominal input voltage, and rated output current unless otherwise noted.

## ABSOLUTE MAXIMUM RATINGS

Input Voltage	120% × rated voltage
Output Short-Circuit Duration	Momentary
Internal Power Dissipation	2.5W
Junction Temperature	+125°C
Package Thermal Resistance	16°C/W
Lead Temperature (soldering, 10 seconds)	+300°C

## MECHANICAL

Marked with specific model number ordered

Pin 4 is missing on single output models

NOTES:  
 All dimensions are in inches (millimeters)  
 GRID: 0.100 inches (2.54 millimeters)  
 MATERIAL: Low thermal resistance molding compound which has excellent chemical resistance, wide operating temperature range and good electrical properties under high humidity environments. Lead material is brass with a hot-solder-dipped surface to allow ease of solderability.



# PWR5XX Series

## 4W Rated Output Power UNREGULATED DC/DC CONVERTER SERIES

### FEATURES

- Isolation Voltage Tested per UL544, VDE750, and CSAC22.2 Dielectric Withstand Requirement
- Barrier Leakage Current 100% Tested at 240VAC
- Quad Channel
- Single or Dual Unregulated Outputs
- Wide Operating Temperature Range:  $-40^{\circ}\text{C}$  to  $+100^{\circ}\text{C}$
- Input and Output Filtering
- Six-Sided Shielding

diverse applications as process control, telecommunications, portable equipment, medical systems, airborne and shipboard electronic circuits, and automatic test equipment.

Thirty-six models allow the user to select input voltages ranging from +5VDC to +48VDC and output voltages of +5, +12, +15,  $\pm 5$ ,  $\pm 12$ , or  $\pm 15\text{V}$ .

Surface-mounted devices and manufacturing processes are used in the PWR5XX Series to give the user a device which is more environmentally rugged than most DC/DC converters. The use of surface-mount technologies also gives the PWR5XX Series superior isolation voltage.

### DESCRIPTION

The PWR5XX Series offers a large selection of unregulated four-watt DC/DC converters for use in

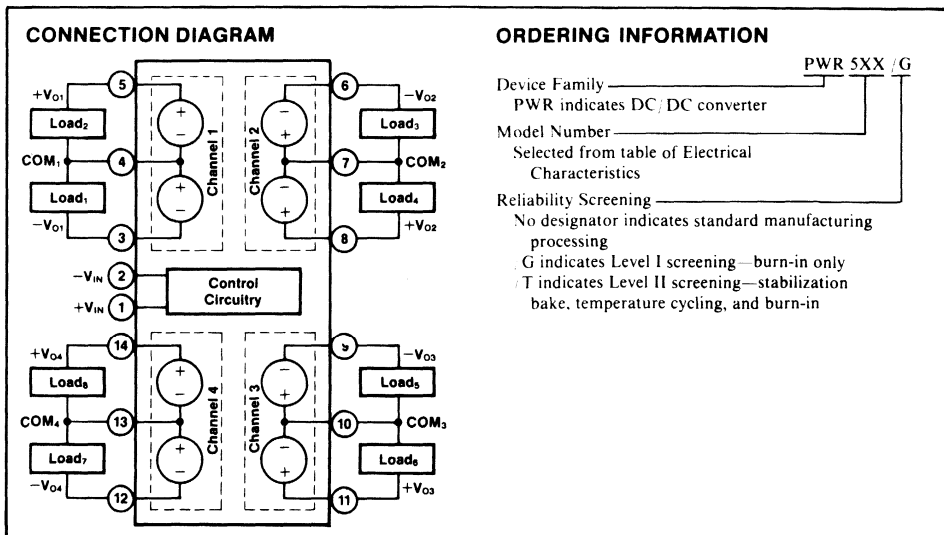

International Airport Industrial Park - P.O. Box 11400 - Tucson, Arizona 85734 - Tel. (602) 746-1111 - Twx: 910-952-1111 - Cable: BBRCORP - Telex: 66-6491

PDS-674B

# SPECIFICATIONS

## ELECTRICAL CHARACTERISTICS<sup>(1)</sup>

Model	Nominal Input Voltage (VDC)	Rated <sup>(2)</sup> Output Voltage (VDC)	Rated <sup>(2)</sup> Output Current (mA)	Maximum Input Current (mA)
PWR500	5	5	200	1300
PWR501		12	84	1290
PWR502		15	67	1230
PWR503		±5	±100	1300
PWR504		±12	±42	1290
PWR505	±15	±34	1230	
PWR506	12	5	200	490
PWR507		12	84	444
PWR508		15	67	444
PWR509		±5	±100	490
PWR510		±12	±42	444
PWR511	±15	±34	444	
PWR512	15	5	200	390
PWR513		12	84	355
PWR514		15	67	355
PWR515		±5	±100	390
PWR516		±12	±42	355
PWR517	±15	±34	355	
PWR518	24	5	200	245
PWR519		12	84	222
PWR520		15	67	222
PWR521		±5	±100	245
PWR522		±12	±42	222
PWR523	±15	±34	222	
PWR524	28	5	200	210
PWR525		12	84	190
PWR526		15	67	190
PWR527		±5	±100	210
PWR528		±12	±42	190
PWR529	±15	±34	190	
PWR530	48	5	200	123
PWR531		12	84	111
PWR532		15	67	111
PWR533		±5	±100	123
PWR534		±12	±42	111
PWR535	±15	±34	111	

## COMMON SPECIFICATIONS<sup>(1)</sup>

Parameter	Conditions	Min	Typ	Max	Units
<b>INPUT</b>					
Voltage Range		±20% of Rated Input			
Input Ripple Current	I <sub>LOAD</sub> = Rated Load		70		mA, p-p
<b>ISOLATION</b>					
Rated Voltage		750			VDC
Resistance			10		GΩ
Capacitance			55		pF
Leakage Current	V <sub>ISO</sub> = 240VAC			15	μA
<b>OUTPUT</b>					
Voltage Accuracy	I <sub>LOAD</sub> = Rated Load			±5	%
Voltage (No Load)	V <sub>OUT</sub> = 5 Models			7	VDC
	V <sub>OUT</sub> = 12 Models			15	VDC
	V <sub>OUT</sub> = 15 Models			18	VDC
Ripple Voltage	I <sub>LOAD</sub> = Rated Load		1		% of V <sub>OUT</sub> , D-P
Line Regulation			1		%/%
<b>TEMPERATURE</b>					
Specification		-25		+85	°C
Operation		-40		+100	°C
Storage		-55		+125	°C

NOTE: (1) Specifications typical at T<sub>A</sub> = +25°C, nominal input voltage, and rated output current unless otherwise noted. (2) Specifications apply to each output.

## ABSOLUTE MAXIMUM RATINGS

Input Voltage	120% × Rated voltage
Output Short-Circuit Duration	Momentary
Internal Power Dissipation	2.5W
Junction Temperature	+150°C
Package Thermal Resistance	38°C/W
Lead Temperature (soldering, 10 seconds)	+300°C

## MECHANICAL

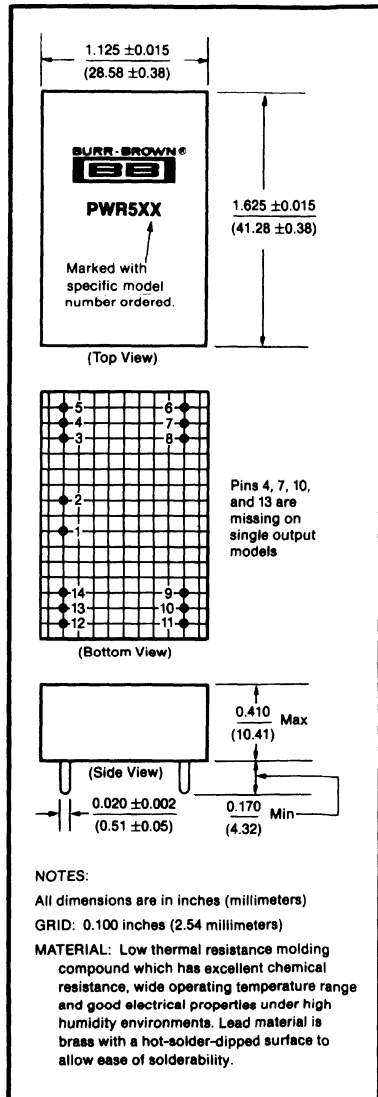





# PWR6XX Series

## 2W Rated Output Power REGULATED DC/DC CONVERTER SERIES

### FEATURES

- Isolation Voltage Tested per UL544, VDE750, and CSAC22.2 Dielectric Withstand Requirement
- Barrier Leakage Current 100% Tested at 240VAC
- Single Channel
- Single or Dual Regulated Outputs
- Linear Output Regulation
- Wide Operating Temperature Range:  $-40^{\circ}\text{C}$  to  $+95^{\circ}\text{C}$
- Input and Output Filtering
- Six-Sided Shielding

diverse applications as process control, telecommunications, portable equipment, medical systems, airborne and shipboard electronic circuits, and automatic test equipment.

Thirty-six models allow the user to select input voltages ranging from +5VDC to +48VDC and output voltages of +5, +12, +15,  $\pm 5$ ,  $\pm 12$ , or  $\pm 15\text{V}$ .

Surface-mounted devices and manufacturing processes are used in the PWR6XX Series to give the user a device which is more environmentally rugged than most DC/DC converters. The use of surface-mount technologies also gives the PWR6XX Series superior isolation voltage. Each PWR6XX Series unit is tested in compliance with the dielectric withstand voltage requirements of UL544, VDE750, and CSAC22.2.

### DESCRIPTION

The PWR6XX Series offers a large selection of regulated two-watt DC/DC converters for use in such

#### ORDERING INFORMATION

PWR 6XX /G

Device Family \_\_\_\_\_

PWR indicates DC/DC converter

Model Number \_\_\_\_\_

Selected from table of Electrical Characteristics

Reliability Screening \_\_\_\_\_

No designator indicates standard manufacturing processing

/G indicates Level I screening—burn-in only

/T indicates Level II screening—stabilization bake, temperature cycling, and burn-in

#### TYPICAL APPLICATIONS

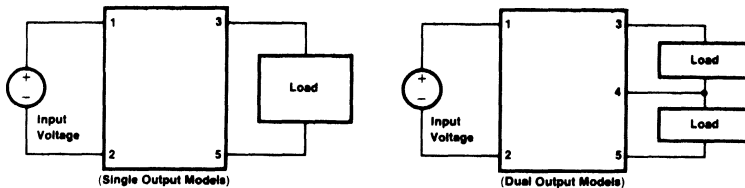

# SPECIFICATIONS

## ELECTRICAL SPECIFICATIONS<sup>(1)</sup>

Model	Nominal Input Voltage (VDC)	Rated Output Voltage (VDC)	Rated Output Current (mA)	Input Current		Reflected Ripple Current, typ (mA)	Regulation		Efficiency, min (%)
				No Load, typ (mA)	Rated Load, typ (mA)		Line, typ (%)	Load, typ (%)	
PWR600	5	5	400	45	645	25	0.02	0.04	59
PWR601		12	167	45	597	25	0.02	0.04	63
PWR602		15	134	45	580	25	0.02	0.04	64
PWR603		±5	±200	45	645	25	0.02	0.04	60
PWR604		±12	±84	45	600	25	0.02	0.04	63
PWR605		±15	±67	45	580	25	0.02	0.04	64
PWR606	12	5	400	22	268	20	0.02	0.04	59
PWR607		12	167	22	248	20	0.02	0.04	63
PWR608		15	134	22	241	20	0.02	0.04	64
PWR609		±5	±200	22	269	20	0.02	0.04	60
PWR610		±12	±84	22	249	20	0.02	0.04	63
PWR611		±15	±67	22	243	20	0.02	0.04	64
PWR612	15	5	400	15	214	20	0.02	0.04	59
PWR613		12	167	15	199	20	0.02	0.04	63
PWR614		15	134	15	193	20	0.02	0.04	64
PWR615		±5	±200	15	215	20	0.02	0.04	60
PWR616		±12	±84	15	200	20	0.02	0.04	63
PWR617		±15	±67	15	195	20	0.02	0.04	64
PWR618	24	5	400	10	134	15	0.02	0.04	59
PWR619		12	167	10	124	15	0.02	0.04	63
PWR620		15	134	10	120	15	0.02	0.04	64
PWR621		±5	±200	10	135	15	0.02	0.04	60
PWR622		±12	±84	10	126	15	0.02	0.04	63
PWR623		±15	±67	10	122	15	0.02	0.04	64
PWR624	28	5	400	10	114	15	0.02	0.04	59
PWR625		12	167	10	107	15	0.02	0.04	63
PWR626		15	134	10	104	15	0.02	0.04	64
PWR627		±5	±200	10	114	15	0.02	0.04	60
PWR628		±12	±84	10	108	15	0.02	0.04	63
PWR629		±15	±67	10	105	15	0.02	0.04	64
PWR630	48	5	400	10	67	10	0.02	0.04	59
PWR631		12	167	10	63	10	0.02	0.04	63
PWR632		15	134	10	63	10	0.02	0.04	64
PWR633		±5	±200	10	67	10	0.02	0.04	60
PWR634		±12	±84	10	63	10	0.02	0.04	63
PWR635		±15	±67	10	63	10	0.02	0.04	64

## COMMON SPECIFICATIONS<sup>(1)</sup>

Parameter	Conditions	Min	Typ	Max	Units
<b>INPUT</b>					
Voltage Range	$V_{IN} = 5V$ Models $V_{IN} = 12V$ Models $V_{IN} = 15V$ Models $V_{IN} = 24V$ Models $V_{IN} = 28V$ Models $V_{IN} = 48V$ Models	4.5 10.8 13.8 21.6 25.2 43.2		5.5 13.5 16.5 26.5 31.0 53.0	VDC VDC VDC VDC VDC VDC
<b>ISOLATION</b>					
Rated Voltage		1000			VDC
Test Voltage	60 Seconds, 60Hz	3000			$V_{PK}$
Resistance			10		GΩ
Capacitance			140		pF
Leakage Current	240V, 60Hz			20	μA, rms
<b>OUTPUT</b>					
Voltage Accuracy			±0.5	±1	%
Voltage Balance	Dual Output Units Only		±0.3		%
Temperature Coefficient	-25°C ≤ $T_A$ ≤ -85°C		±0.01		%/°C
Ripple and Noise	BW = DC to 10MHz		30		mV, p-p
<b>TEMPERATURE</b>					
Specification		-25		+85	°C
Operation		-40		+95	°C
Storage		-55		+125	°C

NOTE: (1) Specifications typical at  $T_A = +25^\circ\text{C}$ , nominal input voltage, and rated output current unless otherwise noted.

**MECHANICAL**

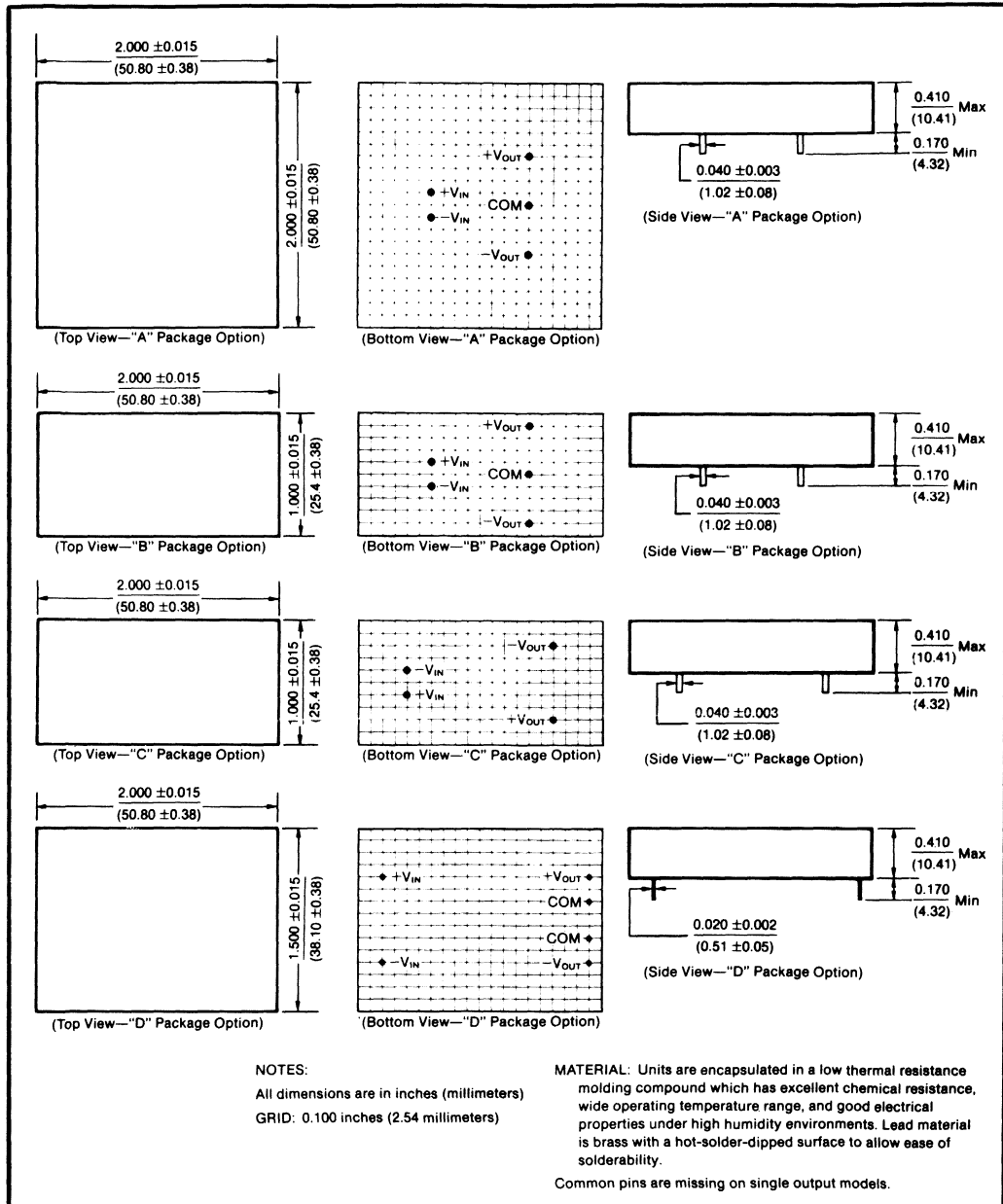

**ABSOLUTE MAXIMUM RATINGS**

Input Voltage .....	120% of nominal
Output Short-Circuit Duration .....	5 seconds
Internal Power Dissipation .....	1.5W
Lead Temperature (soldering, 10 seconds) .....	+300°C
Junction Temperature .....	+150°C
Package Thermal Resistance (Junction-to-Ambient, $\theta_{JA}$ ) ..	45°C/W



# PWR7XX Series

## 5W Rated Output Power REGULATED DC/DC CONVERTER SERIES

### FEATURES

- Isolation Voltage Tested per UL544, VDE750, and CSAC22.2 Dielectric Withstand Requirement
- Barrier Leakage Current 100% Tested at 240VAC
- Single Channel
- Single or Dual Regulated Outputs
- Linear Output Regulation
- Wide Operating Temperature Range: -40°C to +100°C
- Input and Output Filtering
- Six-Sided Shielding

### DESCRIPTION

The PWR7XX Series offers a large selection of regulated 5W DC/DC converters for use in such diverse applications as process control, telecommunications, portable equipment, medical systems, airborne and shipboard electronic circuits, and automatic test equipment.

Thirty-six models allow the user to select input voltages ranging from +5VDC to +48VDC and output voltages of +5, +12, +15,  $\pm 5$ ,  $\pm 12$ , or  $\pm 15$ V.

Surface-mounted devices and manufacturing processes are used in the PWR7XX Series to give the user a device which is more environmentally rugged than most DC/DC converters. The use of surface-mount technologies also gives the PWR7XX Series superior isolation voltage. Each PWR7XX Series unit is tested in compliance with the dielectric withstand voltage requirements of UL544, VDC750, and CSAC22.2.

### ORDERING INFORMATION

PWR 7XX / G

Device Family \_\_\_\_\_

PWR indicates DC/DC converter

Model Number \_\_\_\_\_

Selected from table of Electrical Characteristics

Reliability Screening \_\_\_\_\_

No designator indicates standard manufacturing processing

/G indicates Level I screening—burn-in only

/T indicates Level II screening—stabilization bake, temperature cycling, and burn-in

### TYPICAL APPLICATIONS

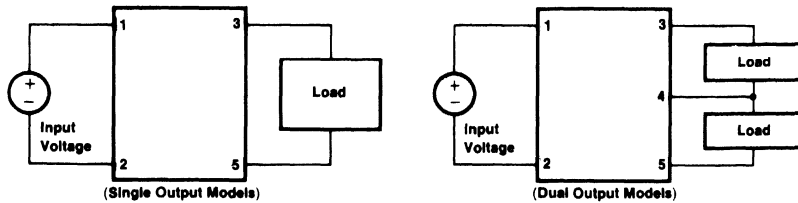

International Airport Industrial Park · P.O. Box 11400 · Tucson, Arizona 85734 · Tel. (602) 746-1111 · Twx: 910-952-1111 · Cable: BBRCORP · Telex: 66-6491

PDS-662A

# SPECIFICATIONS

## ELECTRICAL SPECIFICATIONS<sup>(1)</sup>

Model	Nominal Input Voltage (VDC)	Rated Output Voltage (VDC)	Rated Output Current (mA)	Input Current		Reflected Ripple Current, typ (mA) p-p	Regulation		Efficiency, min (%)
				No Load, typ (mA)	Rated Load, typ (mA)		Line, typ (%)	Load, typ (%)	
PWR700	5	5	1000	168	1600	30	.02	.04	61
PWR701		12	417	168	1535	30	.02	.04	63
PWR702		15	334	168	1490	30	.02	.04	65
PWR703		±5	±500	168	1560	30	.02	.04	62
PWR704		±12	±209	168	1490	30	.02	.04	65
PWR705		±15	±167	168	1450	30	.02	.04	67
PWR706	12	5	1000	38	620	10	.02	.04	61
PWR707		12	417	38	550	10	.02	.04	63
PWR708		15	334	38	535	10	.02	.04	65
PWR709		±5	±500	38	640	10	.02	.04	62
PWR710		±12	±209	38	550	10	.02	.04	65
PWR711		±15	±167	38	535	10	.02	.04	67
PWR712	15	5	1000	35	510	10	.02	.04	61
PWR713		12	417	35	490	10	.02	.04	63
PWR714		15	334	35	470	10	.02	.04	65
PWR715		±5	±500	35	520	10	.02	.04	62
PWR716		±12	±209	35	480	10	.02	.04	65
PWR717		±15	±167	35	455	10	.02	.04	67
PWR718	24	5	1000	33	320	20	.02	.04	61
PWR719		12	417	33	305	20	.02	.04	63
PWR720		15	334	33	300	20	.02	.04	65
PWR721		±5	±500	33	330	20	.02	.04	62
PWR722		±12	±209	33	310	20	.02	.04	65
PWR723		±15	±167	33	305	20	.02	.04	67
PWR724	28	5	1000	33	280	20	.02	.04	61
PWR725		12	417	33	270	20	.02	.04	63
PWR726		15	334	33	260	20	.02	.04	65
PWR727		±5	±500	33	280	20	.02	.04	62
PWR728		±12	±209	33	270	20	.02	.04	65
PWR729		±15	±167	33	260	20	.02	.04	67
PWR730	48	5	1000	31	165	10	.02	.04	61
PWR731		12	417	31	160	10	.02	.04	63
PWR732		15	334	31	155	10	.02	.04	65
PWR733		±5	±500	31	165	10	.02	.04	62
PWR734		±12	±209	31	155	10	.02	.04	65
PWR735		±15	±167	31	155	10	.02	.04	67

## COMMON SPECIFICATIONS<sup>(1)</sup>

Parameter	Conditions	Min	Typ	Max	Units	
<b>INPUT</b>						
Voltage Range	V <sub>IN</sub> = 5V Models V <sub>IN</sub> = 12V Models V <sub>IN</sub> = 15V Models V <sub>IN</sub> = 24V Models V <sub>IN</sub> = 28V Models V <sub>IN</sub> = 48V Models	4.65 11.00 13.70 21.00 25.00 44.50		6 15 17 27 31 53	VDC VDC VDC VDC VDC VDC	
<b>ISOLATION</b>						
Rated Voltage	60 Seconds, 60Hz	1000			VDC	
Test Voltage		3000			V <sub>PK</sub>	
Resistance				10		GΩ
Capacitance				170		pF
Leakage Current	240V rms, 60Hz			25	μA, rms	
<b>OUTPUT</b>						
Voltage Accuracy	Dual Output Units Only -25°C ≤ T <sub>A</sub> ≤ +85°C BW = DC to 10MHz		±0.5	±1	%	
Voltage Balance			±0.3		%	
Temperature Coefficient			±0.01		%/°C	
Ripple and Noise				30		mV, p-p
<b>TEMPERATURE</b>						
Specification		-25		+85	°C	
Operation		-40		+100	°C	
Storage		-55		+125	°C	

NOTE: (1) Specifications typical at T<sub>A</sub> = +25°C, nominal input voltage, and rated output current unless otherwise noted.

MECHANICAL

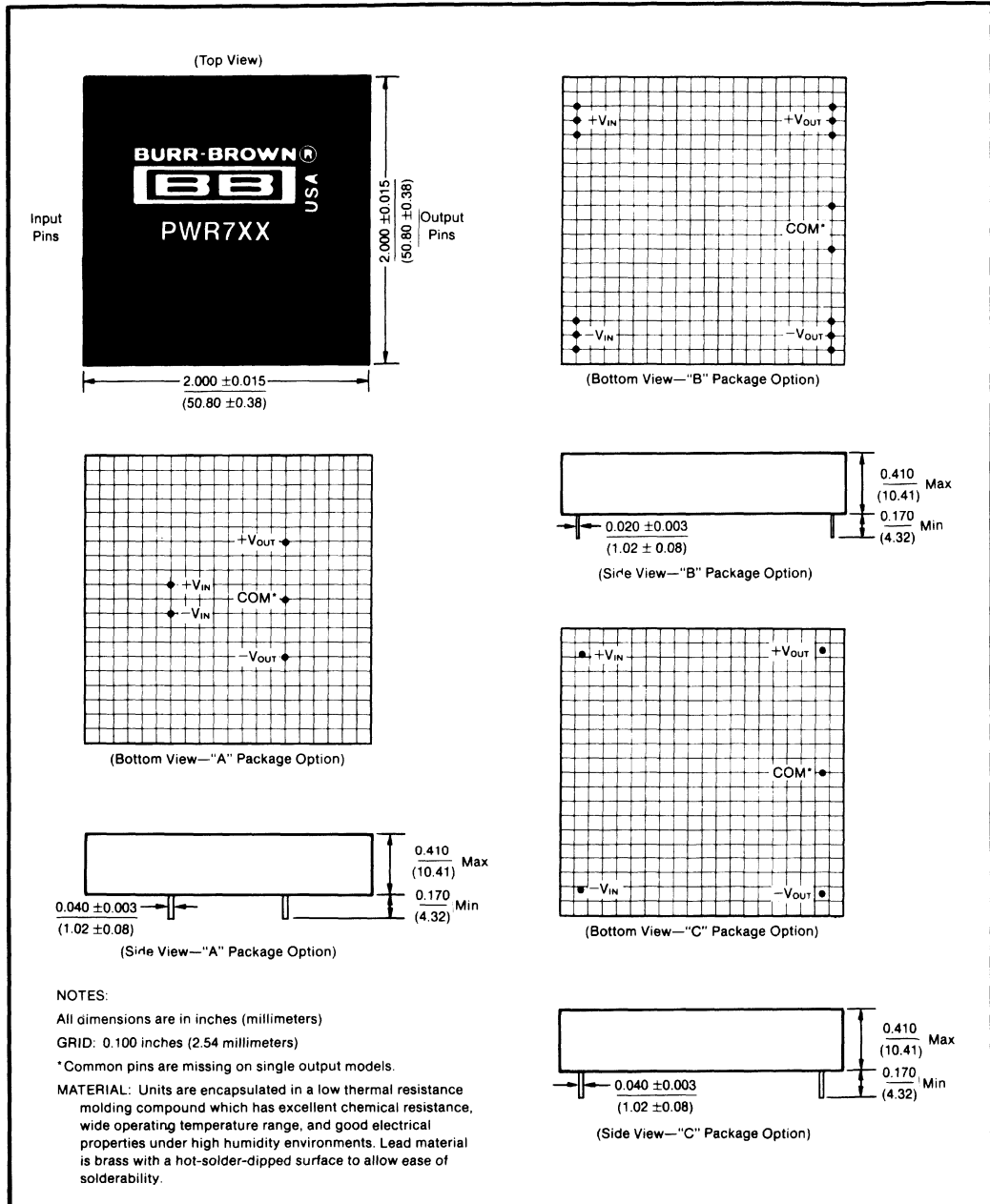

ABSOLUTE MAXIMUM RATINGS

Input Voltage	120% of nominal
Output Short-Circuit Duration	5 seconds
Internal Power Dissipation	3.5W
Lead Temperature (soldering, 10 seconds)	+300°C
Junction Temperature	+150°C
Package Thermal Resistance, Junction-to-Ambient, θ <sub>JA</sub>	15°C/W



# PWR8XX Series

## 5 Watts—Triple-Output UNREGULATED DC/DC CONVERTER SERIES

### FEATURES

- Isolation Voltage Tested per UL544, VDE750, and CSAC22.2 Dielectric Withstand Requirement
- Barrier Leakage Current 100% Tested at 240VAC
- Single Channel
- Single or Dual Unregulated Outputs
- Wide Operating Temperature Range:  $-40^{\circ}\text{C}$  to  $+100^{\circ}\text{C}$
- Input and Output Filtering
- Six-Sided Shielding

### DESCRIPTION

The PWR8XX Series offers a large selection of unregulated 5W DC/DC converters for use in such

diverse applications as process control, telecommunications, portable equipment, medical systems, airborne and shipboard electronic circuits, and automatic test equipment.

Twelve models allow the user to select input voltages ranging from +5VDC to +48VDC and output voltages of +5 and  $\pm 12$ VDC or  $\pm 15$ VDC.

Surface-mounted devices and manufacturing processes are used in the PWR8XX Series to give the user a device which is more environmentally rugged than most DC/DC converters. The use of surface-mount technologies also gives the PWR8XX Series superior isolation voltage. Each PWR8XX Series unit is tested in compliance with the dielectric withstand voltage requirements of UL544, VDC750, and CSAC22.2.

### CONNECTION DIAGRAM

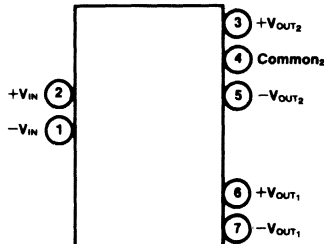

### ORDERING INFORMATION

Device Family \_\_\_\_\_ PWR 8XX /G  
 PWR indicates DC/DC converter  
 Model Number \_\_\_\_\_  
 Selected from table of Electrical Characteristics  
 Reliability Screening \_\_\_\_\_  
 No designator indicates standard manufacturing processing  
 /G indicates Level I screening—burn-in only  
 /T indicates Level II screening—stabilization bake, temperature cycling, and burn-in

### TYPICAL APPLICATION

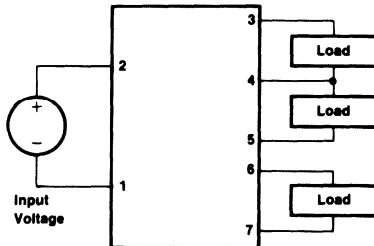

# SPECIFICATIONS

## ELECTRICAL CHARACTERISTICS<sup>(1)</sup>

Model	Nominal Input Voltage (VDC)	Channel 1 Rated Output		Channel 2 Rated Output		Maximum Input Current (mA)
		Voltage (VDC)	Current (mA)	Voltage (VDC)	Current (mA)	
PWR800	5	5	250	±12	±156	1665
PWR801		5	250	±15	±125	1665
PWR802	12	5	250	±12	±156	695
PWR803		5	250	±15	±125	695
PWR804	15	5	250	±12	±156	555
PWR805		5	250	±15	±125	555
PWR806	24	5	250	±12	±156	345
PWR807		5	250	±15	±125	345
PWR808	28	5	250	±12	±156	295
PWR809		5	250	±15	±125	295
PWR810	48	5	250	±12	±156	170
PWR811		5	250	±15	±125	170

## COMMON SPECIFICATIONS<sup>(1)</sup>

Parameter	Conditions	Min	Typ	Max	Units
<b>INPUT</b>					
Voltage Range		±20% of Rated Input			
Input Ripple Current	$I_{LOAD} = \text{Rated Load}$		50		mA, p-p
<b>ISOLATION</b>					
Rated Voltage		1000			VDC
Test Voltage	60Hz, 60 seconds	3000			$V_{PEAK}$
Resistance			10		GΩ
Capacitance			80		pF
Leakage Current	$V_{ISO} = 240VAC$			15	μA
<b>OUTPUT</b>					
Voltage Accuracy	$I_{LOAD} = \text{Rated Load}$			±5	%
Voltage (No Load)	$V_{OUT} = 5V$ Models			7	VDC
	$V_{OUT} = 12V$ Models			15	VDC
	$V_{OUT} = 15V$ Models			18	VDC
Ripple Voltage	$I_{LOAD} = \text{Rated Load}$		100		mV, p-p
Line Regulation			1		%/%
<b>TEMPERATURE</b>					
Specification		-25		+85	°C
Operation		-40		+100	°C
Storage		-55		+125	°C

NOTE: (1) Specifications typical at  $T_A = +25^\circ C$ , nominal input voltage, and rated output current unless otherwise noted.

## ABSOLUTE MAXIMUM RATINGS

Input Voltage	120% × rated voltage
Output Short-Circuit Duration	Momentary
Internal Power Dissipation	4W
Junction Temperature	+175°C
Package Thermal Resistance	27°C/W
Lead Temperature (soldering, 10 seconds)	+300°C

## MECHANICAL

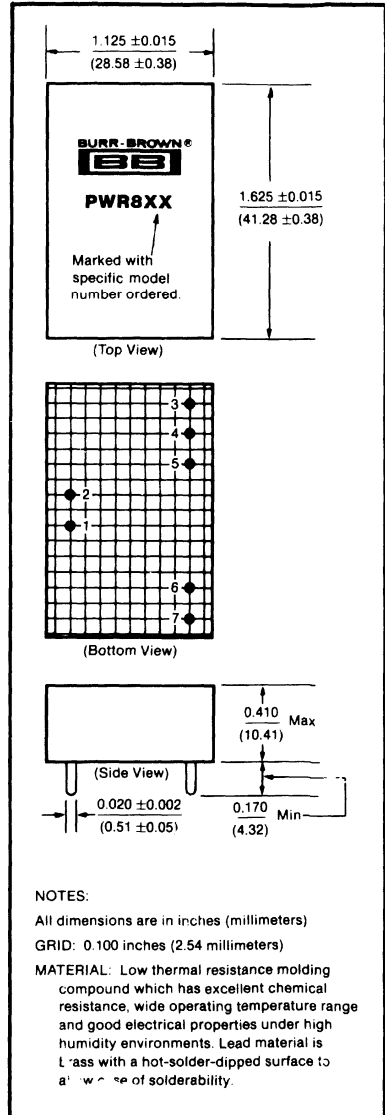

### NOTES:

All dimensions are in inches (millimeters)

GRID: 0.100 inches (2.54 millimeters)

**MATERIAL:** Low thermal resistance molding compound which has excellent chemical resistance, wide operating temperature range and good electrical properties under high humidity environments. Lead material is L'ass with a hot-solder-dipped surface to a' improve solderability.





# PWR1017

## Four-Channel, Dual-Output, Synchronizable UNREGULATED DC/DC CONVERTER

### FEATURES

- Synchronizable
- All Outputs Isolated
- Output Power to 3W
- High Isolation Voltage—1000Vpk
- Six-Sided Shielding
- Input and Output Filtering
- Low Profile Package—0.4" High

### APPLICATIONS

- Power for High Resolution Data Acquisition
- Precision Test Equipment
- Spot Regulator
- Process Control
- Portable Equipment
- Multiple Power Supplies

### DESCRIPTION

The PWR1017 is a four-channel, dual-output unregulated DC/DC converter designed for low noise applications where high efficiency and switching synchronization are required.

Any unit whose slave pin is connected to another unit's master pin will cause the oscillators to lock together. The PWR1017 may also be driven from a system master clock. The free running switching frequency is 250kHz.

The PWR1017 has four isolated plus and minus output voltages approximately equal to the magnitude of the input voltage. It operates over an input voltage range of 10VDC to 18VDC. Rated output current for the PWR1017 is 25mA for all outputs.

Isolation voltage between the input and any of the four output circuits is 1000Vpk continuous. The same isolation specification applies between any of the four dual outputs.

Six-sided shielding suppresses electromagnetic radiation which could disturb sensitive analog measurements or interfere with system timing signals. Filtering the PWR1017 input and outputs minimizes the effects of electrical noise on the source and loads of the converter.

Each PWR1017 is tested in compliance with UL544, VDE750, and CSA C22.2 dielectric withstand specifications. In addition, barrier leakage current is 100% tested.

### CONNECTION DIAGRAM

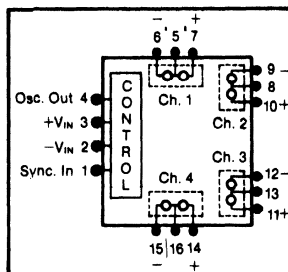

### MECHANICAL

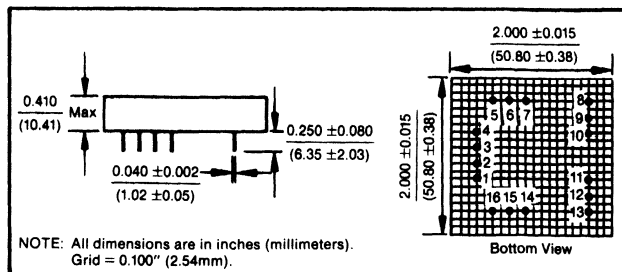

NOTE: All dimensions are in inches (millimeters).  
Grid = 0.100" (2.54mm).

International Airport Industrial Park - P.O. Box 11400 - Tucson, Arizona 85734 - Tel. (802) 746-1111 - Twx: 910-952-1111 - Cable: BBRCORP - Telex: 66-6491

PDS-706A

# SPECIFICATIONS

## ELECTRICAL

At  $T_A = 25^\circ\text{C}$ ,  $V_{IN} = 15\text{VDC}$ ,  $I_{LOAD} = \pm 25\text{mA}$  and in free running mode unless otherwise noted.

PARAMETER	CONDITIONS	PWR1017			UNITS
		MIN	NORM	MAX	
<b>INPUT</b>					
Rated Voltage <sup>(1)</sup>		10	15	18	VDC
Voltage Range					VDC
Input Current	$I_{LOAD} = 0$		70		mA
	$I_{LOAD} = \text{Rated Load}$		285	350	mA
Ripple Current	$I_{LOAD} = \text{Rated Load}$		80		mA, p-p
<b>ISOLATION</b>					
Rated Voltage <sup>(3)</sup>	Test: 60sec, 60Hz, 3000V, pk	1000			VDC
Resistance			10		GΩ
Capacitance			15		pF
Leakage Current	$V_{ISO} = 240\text{VAC}$ , 60Hz		0.9	3	μA
<b>OUTPUT</b>					
Rated Voltage	$I_{LOAD} = 0\text{mA}$	±16	±15	±18	VDC
Voltage Range	$I_{LOAD} = \text{Rated Load}$	±14.25	±16.5	±15.75	VDC
Rated Current	Each output	±25			mA
	Total of all outputs	200			mA
Current Range	Each output	0		±40	mA
	Total of all outputs	0		500	mA
Line Regulation	$10\text{VDC} < V_{IN} < 18\text{VDC}$		1.16		mV/mV
Load Regulation	$0 > I_{LOAD} > 25\text{mA}$		12.5		mV/mA
Ripple Voltage	$I_{LOAD} = 0$		±10		mV, pk
	$I_{LOAD} = \text{Rated Load}$			±100	mV, pk
<b>SYNCHRONIZATION<sup>(2)</sup></b>					
$f_{SYNC}$ Range	$V_{SYNC} > 6\text{Vp-p}$	400		700	kHz
$V_{SYNC}$ Range	$400\text{kHz} < f_{SYNC} < 700\text{kHz}$	6.4		36	V, p-p
Oscillator Output Fanout				2	Sync Inputs
$V_{SYNC, max}$	Max deviation from $-V_{IN}$			50	V
$V_{SYNC}$ Duty Cycle		5	50	60	%
<b>TEMPERATURE</b>					
Specification		-25		+85	°C
Operating		-40		+100	°C
Storage		-55		+125	°C

NOTE: (1) Other voltages available on request. (2) Operating frequency (in sync mode) =  $f_{SYNC}/2$ . Oscillator frequency (pin 4, free running) = 2 (f operation). Oscillator frequency (pin 4, sync mode) =  $f_{SYNC}$ . (3) Ratings apply input-to-output and are typical channel-to-channel

## ABSOLUTE MAXIMUM RATINGS

Input Voltage	18VDC
Output Current	500mA
Output Short Circuit	
Duration	Momentary

## ORDERING INFORMATION

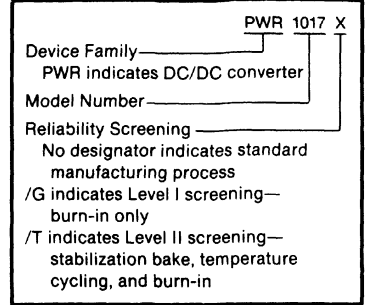

## Control Circuitry Block Diagram

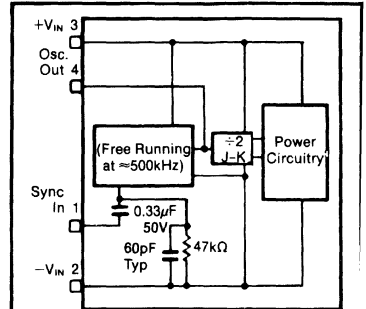

NOTE: Care should be taken when the synchronization input pin is not used, in order to avoid the possibility of noise pick-up and false PLL locking. This could destroy the unit and/or any other units that are coupled to its synchronization output (pin 4). This protection may be accomplished by either tying the synchronization pin to  $-V_{IN}$ , or clipping pin 1 off flush with the module surface. Tying pin 1 to  $-V_{IN}$  is preferred.

## TYPICAL PERFORMANCE CURVES

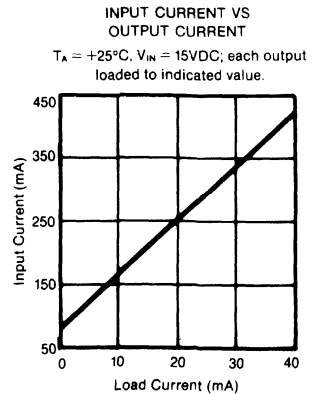
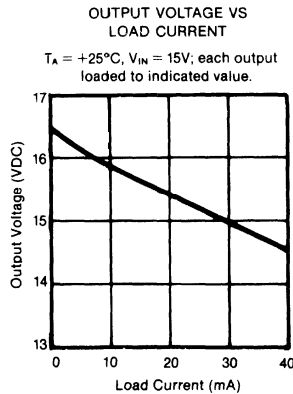
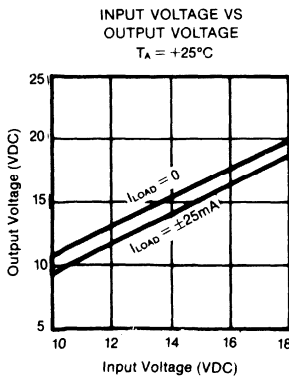

## TYPICAL PERFORMANCE CURVES (CONT)

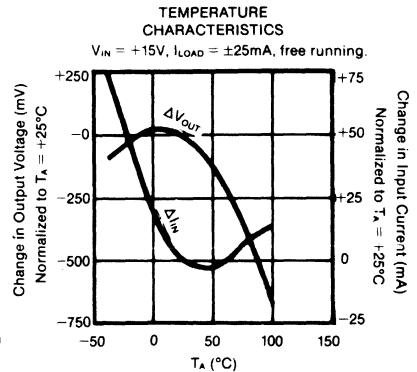
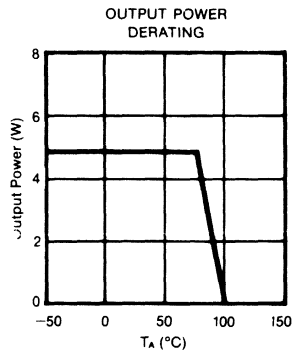
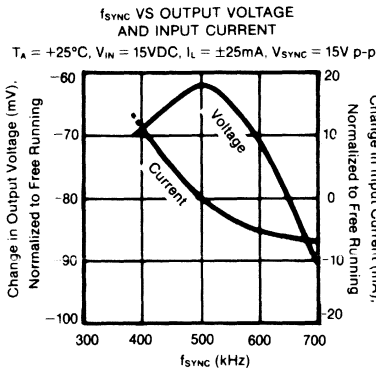
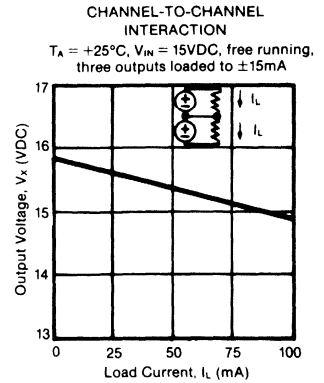
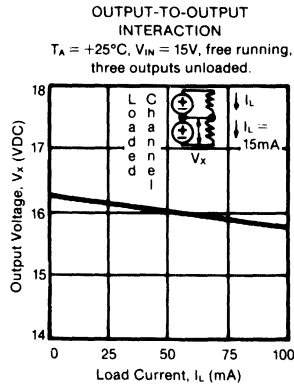
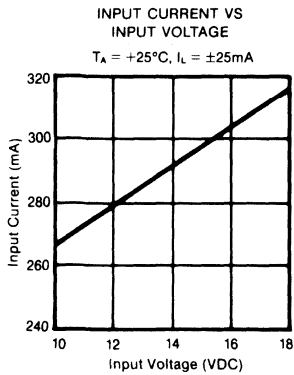

## APPLICATIONS

### TYPICAL OUTPUT CONNECTIONS

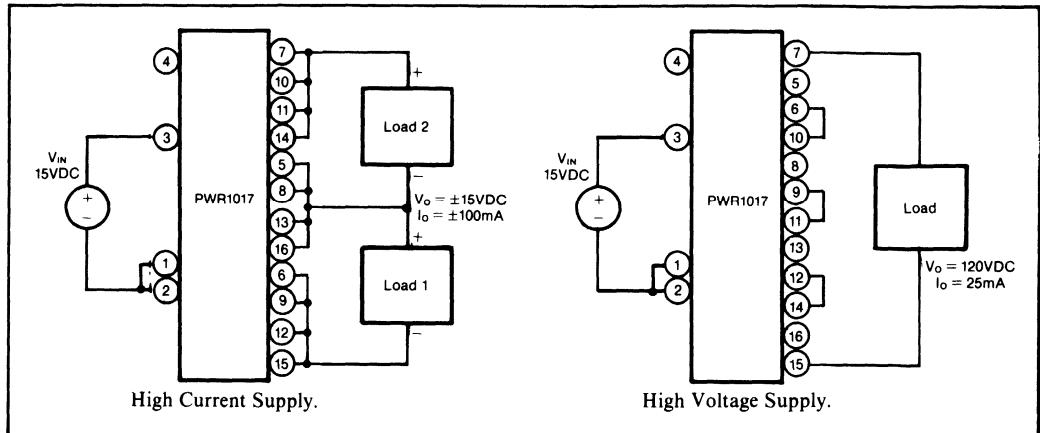

**TYPICAL INPUT CONNECTIONS**

**Single Rail Input Supply**

The PWR1017 can be hooked up in a number of configurations for single input voltages. Each unit may become either a master or a slave. The most common configuration is with a single master and multiple slave units.

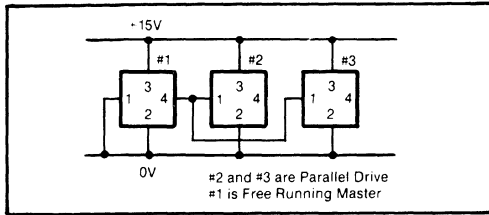

The PWR1017 may also be connected in series where the first unit can either be a master or a slave driven by the system clock.

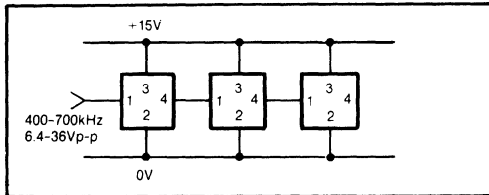

Any combination of serial or parallel may be used.

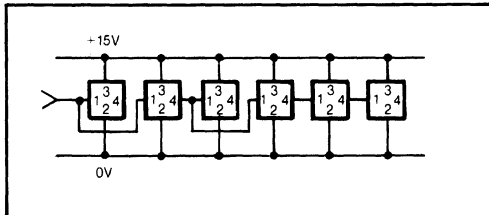

**Split Rail Input Supply**

PWR1017s may be driven by a differential supply and still be synchronized together. Care should be taken not to exceed the 50V maximum deviation from any  $-V_{IN}$ .

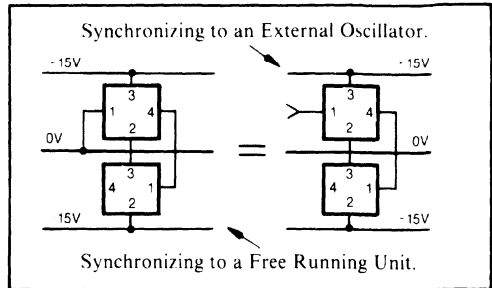

The master pin is a buffered output designed to drive other slave inputs. In split rail applications it is recommended that the external oscillator drive only one unit and all others be driven from the master outputs of other PWR1017s.

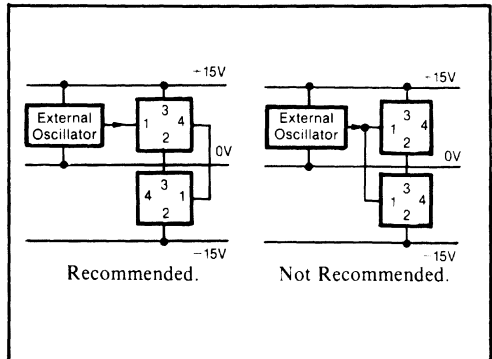



## PWR11XX SERIES

AVAILABLE 1ST QTR '89  
ADVANCE INFORMATION  
SUBJECT TO CHANGE

**NEW**

### 24-Pin DIP, Unregulated, Filtered DC/DC CONVERTER

#### FEATURES

- 24-PIN DIP PACKAGE
- INTERNAL INPUT AND OUTPUT FILTERING
- 50mVp-p RIPPLE AND NOISE WITH NO EXTERNAL COMPONENTS
- SHORT-CIRCUIT PROTECTION
- BUILT-IN STANDOFFS

#### APPLICATIONS

- HIGH-DENSITY PC BOARDS
- COMPUTER PERIPHERALS
- LAN POWER
- PORTABLE EQUIPMENT

#### DESCRIPTION

The PWR11XX Series offers a broad line of low-cost, high-performance, unregulated, single and dual output DC/DC converters in a 24-pin DIP package. These miniature converters offer better performance and lower cost in industry-standard packages and pin-outs. The PWR11XX Series is internally filtered to give a maximum output noise and ripple specification of 50mVp-p. No external parts are necessary to obtain this performance.

Surface mounted components and void free, hard-cast epoxy allow for superior reliability, excellent thermal dissipation, and an extended temperature range of +85°C at no extra cost.

The PWR11XX Series are ideal for use on high-density PC boards where isolated, unregulated, low ripple power is needed. An input PI filter is standard on all models, eliminating the need for external filtering, which uses precious board space. Standoffs allow for PC board cleaning, helping preserve isolation. They also allow for visual inspection of solder joints from above.

The 9VDC output units can supply power to operate LAN circuits in a standard package. The isolation makes the PWR11XX well suited for this application as well as digital-to-analog and analog-to-digital (DACs and ADCs) conversion circuits. Short-circuit protection gives safety to the unit for prototyping and production solder-bridges.

# SPECIFICATIONS

## ELECTRICAL

Specifications at  $T_a = +25^\circ\text{C}$ , Rated Input Voltage, Rated Output Current unless otherwise noted.

PARAMETER	CONDITIONS	MIN	TYP	MAX	UNITS
INPUT Ranges		4.0	5	6.0	VDC
		9.6	12	14.4	VDC
		-19.2	24	28.8	VDC
		38.4	48	57.6	VDC
ISOLATION Rated Voltage Resistance		500	10		VDC GΩ
OUTPUT Rated Voltages Rated Currents Voltage Accuracy Ripple and Noise	See Below See Below 5VDC outputs BW = DC to 10 MHz NO EXTERNAL PARTS			±3 50	VDC mA % mVp-p
REGULATION Line Load	per 1.0% Change in $V_{in}$ 100% to 20% Change in Load		1.2 6		%/% %

## THERMAL

PARAMETER	CONDITIONS	MIN	TYP	MAX	UNITS
Specification Operating Storage		-25 -40 -55		+85 +100 +150	°C °C °C

## ABSOLUTE MAXIMUM RATINGS

Output Short-Circuit Duration	Continuous
Lead Temperature (soldering, 10 sec)	+300°C

## MODEL NUMBERS

### Duals

MODEL	$V_{in}$	$V_{out}$	$I_{out}$
PWR1100	5VDC	5VDC	500mA
PWR1101	5VDC	9VDC	277mA
PWR1102	5VDC	12VDC	208mA
PWR1103	5VDC	15VDC	166mA
PWR1104	5VDC	±5VDC	±250mA
PWR1105	5VDC	±12VDC	±104mA
PWR1106	5VDC	±15VDC	±83mA
PWR1107	12VDC	5VDC	500mA
PWR1108	12VDC	9VDC	277mA
PWR1109	12VDC	12VDC	208mA
PWR1110	12VDC	15VDC	166mA
PWR1111	12VDC	±5VDC	±250mA
PWR1112	12VDC	±12VDC	±104mA
PWR1113	12VDC	±15VDC	±83mA
PWR1114	24VDC	5VDC	500mA
PWR1115	24VDC	9VDC	277mA
PWR1116	24VDC	12VDC	208mA
PWR1117	24VDC	15VDC	166mA
PWR1118	24VDC	±5VDC	±250mA
PWR1119	24VDC	±12VDC	±104mA
PWR1120	24VDC	±15VDC	±83mA
PWR1121	48VDC	5VDC	500mA
PWR1122	48VDC	9VDC	277mA
PWR1123	48VDC	12VDC	208mA
PWR1124	48VDC	15VDC	166mA
PWR1125	48VDC	±5VDC	±250mA
PWR1126	48VDC	±12VDC	±104mA
PWR1127	48VDC	±15VDC	±83mA

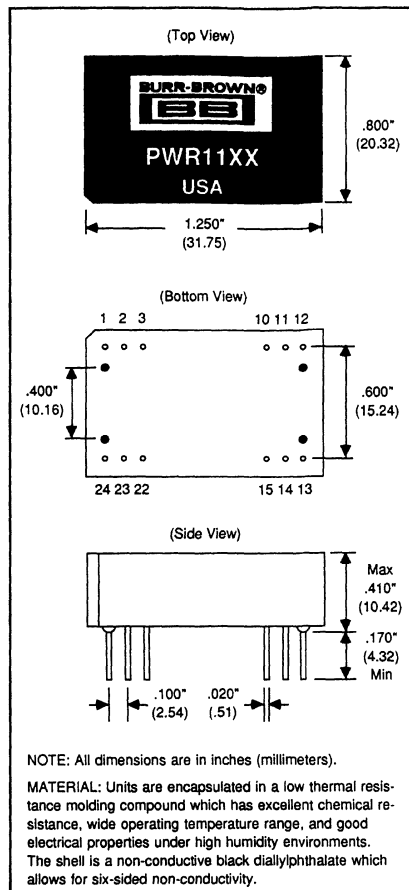

## PIN CONNECTIONS

PIN	SINGLES	DUALS
	FUNCTION	FUNCTION
1	+ $V_{in}$	+ $V_{in}$
2	NC	- $V_{out}$
3	NC	Common
10	- $V_{out}$	Common
11	+ $V_{out}$	+ $V_{out}$
12	- $V_{in}$	- $V_{in}$
13	- $V_{in}$	- $V_{in}$
14	+ $V_{out}$	+ $V_{out}$
15	- $V_{out}$	Common
22	NC	Common
23	NC	- $V_{out}$
24	+ $V_{in}$	+ $V_{in}$



## PWR13XX SERIES

---



---

*NEW*

---



---

AVAILABLE 1ST QTR '89  
ADVANCE INFORMATION  
SUBJECT TO CHANGE

### 24-Pin DIP, Unregulated DC/DC CONVERTER

#### FEATURES

- ISOLATION VOLTAGE TESTED PER UL544, VDE750, AND CSAC22.2 DIELECTRIC WITHSTAND REQUIREMENT
- BARRIER LEAKAGE CURRENT 100% TESTED AT 240VAC
- 24-PIN DIP PACKAGE
- SHORT-CIRCUIT PROTECTION
- BUILT-IN STANDOFFS

#### APPLICATIONS

- MEDICAL INSTRUMENTATION
- ISOLATED PORTABLE EQUIPMENT
- RIGID SAFETY REQUIREMENTS

#### DESCRIPTION

The PWR13XX Series offers a broad line of low-cost, high-performance, unregulated, single and dual output DC/DC converters in a 24-pin DIP package.

It is the only DIP Series of DC/DC converters currently offered that meets the high safety standards of UL, VDE, and CSA. Surface mounted components and void free, hard-cast epoxy allow for superior reliability, excellent thermal dissipation, and an extended temperature range of +85°C at no extra cost.

The PWR13XX Series is ideal for use on high-density PC boards where isolated, unregulated power must meet safety specs. Each PWR13XX Series unit shipped is tested in compliance with the dielectric withstand voltage requirements of UL544, VDE750, and CSAC22.2. Standoffs allow for PC board cleaning, helping preserve isolation. They also allow for visual inspection of solder joints from above. The short-circuit protection gives safety to the unit for prototyping and production solder-bridges.

International Airport Industrial Park • Mailing Address: PO Box 11400 • Tucson, AZ 85734 • Street Address: 6730 S. Tucson Blvd. • Tucson, AZ 85706  
Tel: (602) 746-1111 • Twx: 910-952-1111 • Cable: BBRCORP • Telex: 66-6491 • FAX: (602) 889-1510

PDS-884

# SPECIFICATIONS

## ELECTRICAL

Specifications at  $T_a = +25^\circ\text{C}$ , Rated Input Voltage, Rated Output Current unless otherwise noted.

PARAMETER	CONDITIONS	MIN	TYP	MAX	UNITS
INPUT Ranges		4.5	5	5.5	VDC
		10.8	12	13.2	VDC
		21.6	24	26.4	VDC
		43.2	48	52.8	VDC
ISOLATION Rated Voltage Resistance		500	10		VDC GΩ
OUTPUT Rated Voltages Rated Currents Voltage Accuracy Ripple and Noise	See Below See Below 5VDC outputs BW = DC to 10MHz NO EXTERNAL PARTS		100	±3	VDC mA % mVp-p
REGULATION Line Load	Lowline to Highline 1/4 Load to Full Load		1.2 6		%/% %

## THERMAL

PARAMETER	CONDITIONS	MIN	TYP	MAX	UNITS
Specification		-25		+85	°C
Operating		-40		+100	°C
Storage		-55		+150	°C

## ABSOLUTE MAXIMUM RATINGS

Output Short-Circuit Duration .....	Continuous
Lead Temperature (soldering, 10 sec) .....	+300°C

## MODEL NUMBERS

### Duals

MODEL	$V_{in}$	$V_{out}$	$I_{out}$
PWR1300	5VDC	5VDC	200mA
PWR1301	5VDC	12VDC	83mA
PWR1302	5VDC	15VDC	67mA
PWR1303	5VDC	±12VDC	±42mA
PWR1304	5VDC	±15VDC	±34mA
PWR1305	12VDC	5VDC	200mA
PWR1306	12VDC	12VDC	83mA
PWR1307	12VDC	15VDC	67mA
PWR1308	12VDC	±12VDC	±42mA
PWR1309	12VDC	±15VDC	±34mA
PWR1310	15VDC	5VDC	200mA
PWR1311	15VDC	12VDC	83mA
PWR1312	15VDC	15VDC	67mA
PWR1313	15VDC	±12VDC	±42mA
PWR1314	15VDC	±15VDC	±34mA

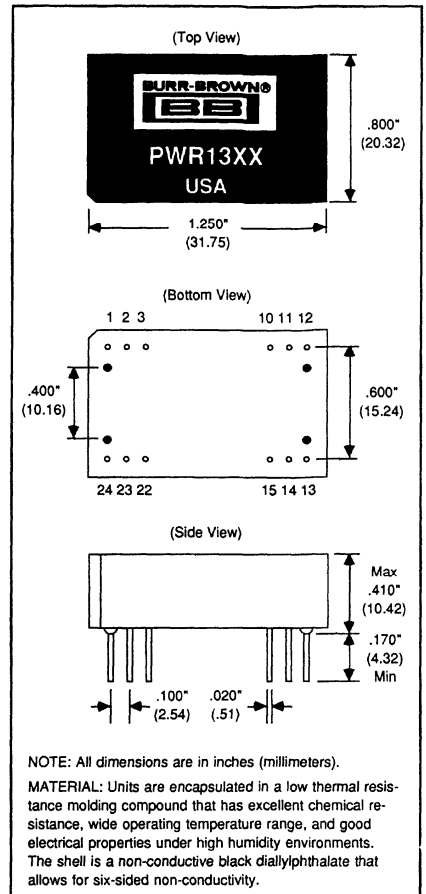

## PIN CONNECTIONS

PIN	SINGLES	DUALS
	FUNCTION	FUNCTION
1	NC	NC
2	NC	-V <sub>OUT</sub>
3	NC	Common
10	-V <sub>OUT</sub>	Common
11	+V <sub>OUT</sub>	+V <sub>OUT</sub>
12	NC	NC
13	-V <sub>IN</sub>	-V <sub>IN</sub>
14	NC	NC
15	NC	
22	NC	NC
23	NC	NC
24	+V <sub>IN</sub>	+V <sub>IN</sub>





PWR1546A

---



---

**NEW**

---



---

## Ultra-Low-Noise, Regulated DC/DC CONVERTER +5VDC In; $\pm 15$ VDC Out

### FEATURES

- 1.0mVp-p MAXIMUM OUTPUT NOISE
- 5W RATED OUTPUT POWER
- SHORT-CIRCUIT PROTECTION
- SIX-SIDED SHIELDING
- INTERNAL INPUT AND OUTPUT FILTERING
- FULLY REGULATED

### APPLICATIONS

- HIGH RESOLUTION DATA ACQUISITION
- PRECISION TEST EQUIPMENT
- HIGH GAIN AMPLIFIERS
- PRECISION INSTRUMENTATION

### DESCRIPTION

The PWR1546A has a maximum of 1.0mVp-p output noise. This unit incorporates input and output filtering along with an internal shield, giving full six-sided shielding that keeps unwanted radiated noise from your circuit. No external parts are required to meet the 1.0mVp-p maximum guaranteed output noise.

The model PWR1546A is a miniature DC/DC converter providing dual isolated  $\pm 15$ VDC outputs from a single +5VDC input. Each output will supply full-rated current over the entire operating range. Each

output is regulated and is protected against all shorts. The isolation barrier is guaranteed to be 750VDC min; this is 250VDC more than most units. For example, the additional voltage allows the PWR1546A to operate while connected across a standard 440VAC power line.

Surface-mounted components and void-free, hard-cast epoxy allows for superior reliability and excellent thermal dissipation. The calculated MTTF (per MIL-HDBK-217 REV. E, Circuit-Stress Analysis Method) is in excess of 100 years at 25°C.

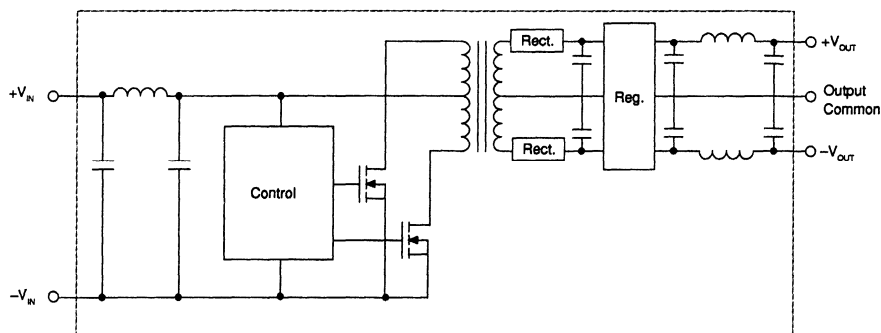

International Airport Industrial Park • P.O. Box 11400 • Tucson, AZ 85734 • Tel: (602) 746-1111 • Twx: 910-952-1111 • Cable: BBRCORP • Telex: 66-6491

PDS-850A

# SPECIFICATIONS

## ELECTRICAL CHARACTERISTICS

Specifications at  $T_A = +25^\circ\text{C}$ , Rated Input Voltage, Rated Output Current unless otherwise noted.

PARAMETER	CONDITIONS	MIN	TYP	MAX	UNITS
<b>INPUT</b>					
Rated Voltage		4.5	5.0	5.5	VDC
Voltage Range					VDC
Current	$I_{LOAD} = 0$		80		mA
Reflected Ripple Current	$I_{LOAD} = \text{Rated Output}$		1650		mA
	BW = DC to 10MHz		18		mAp-p
<b>ISOLATION</b>					
Rated Voltage		750			VDC
Resistance			10		GΩ
Capacitance			110		pF
Leakage Current	$V_{ISO} = 240\text{VAC}, 60\text{HZ}$			15	μArms
Common-Mode Noise Current	BW = DC to 10MHz		1		mAp-p
<b>OUTPUT</b>					
Rated Voltage			±15		VDC
Voltage Accuracy				±1	%
Voltage Balance				±0.5	%
Temperature Coefficient			±0.01		%/°C
Rated Current			±167		mA
Transient Recovery Time	To 0.1% of Final Value		10		msec
<b>REGULATION</b>					
Line	4.5VDC to 5.5VDC		±0.02		%
Load	0mA to ±167mA		0.02		%
<b>OUTPUT NOISE</b>					
Ripple and Noise	BW = DC to 10MHz		0.6	1.0	mVp-p
<b>GENERAL</b>					
Efficiency			60		%
Switching Frequency			50		kHz
MTTF <sup>(1)</sup>			890,000		hours

NOTE: (1) Calculated per MIL-HDBK-217, +25°C, Ground Benign, Circuit-Stress Analysis Method. MTTFs for other environments are available upon request.

## ORDERING INFORMATION

**PWR 1546A X**

Device Family \_\_\_\_\_

PWR indicates DC/DC converter

Model Number \_\_\_\_\_

Reliability Screening \_\_\_\_\_

No designator indicates standard manufacturing process.  
 /G indicates Level I screening—burn-in only.  
 /T indicates Level II screening—stabilization bake, temperature cycling, and burn-in.

## THERMAL CHARACTERISTICS

PARAMETER	MIN	TYP	MAX	UNITS
Specifications	-25		+85	°C
Operating	-40		+100	°C
Storage	-55		+125	°C
Package Thermal Resistance (Junction-to-Ambient)		20		°C/W

## MECHANICAL

(Top View)

(Bottom View)

(Side View)

NOTES: 1) All dimensions are in inches (millimeters)

GRID: 0.100 inches (2.54 millimeters)

MATERIAL: Units are encapsulated in a low thermal resistance molding compound that has excellent chemical resistance, wide operating temperature range, and good electrical properties under high humidity environments.

## ABSOLUTE MAXIMUM RATINGS

Input Voltage	6.0VDC
Output Short-Circuit Duration	Continuous
Internal Power Dissipation	4.0W
Lead Temperature (Soldering, 10sec)	+300°C
Junction Temperature	+150°C

# TYPICAL PERFORMANCE CURVES

$T_A = +25^\circ\text{C}$ ,  $V_{IN} = 5\text{VDC}$ ,  $I_{LOAD} = \pm 167\text{mA}$  unless otherwise noted.

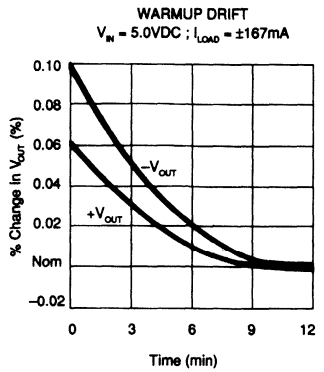
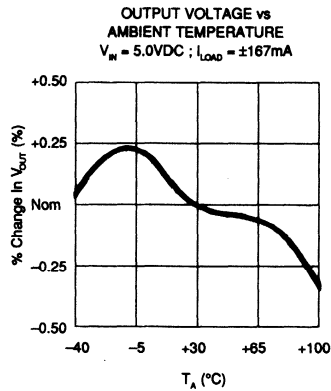
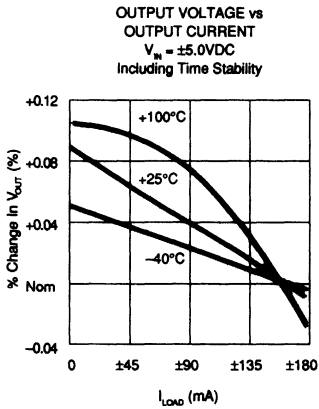
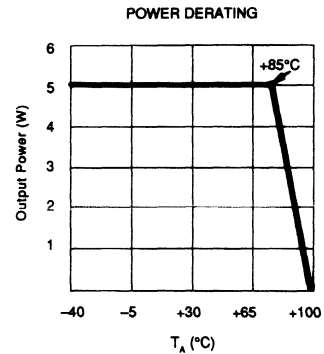
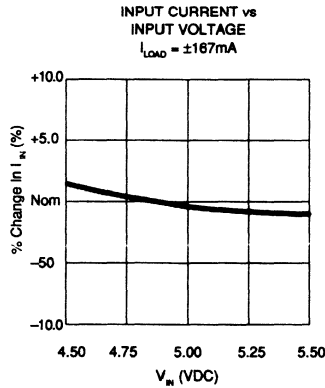
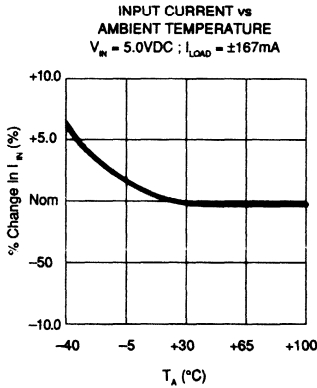
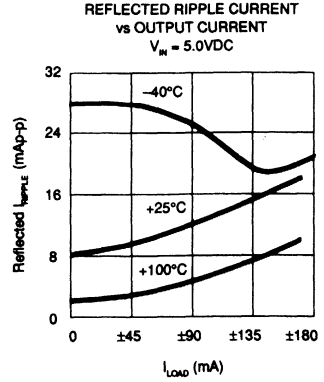
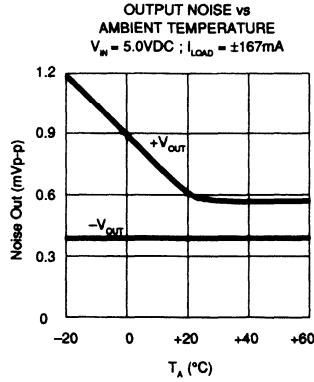
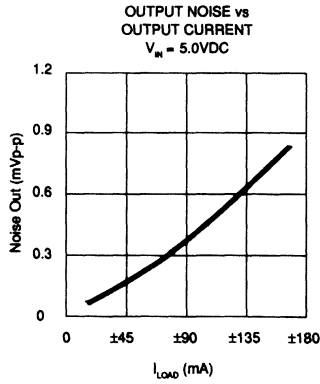



PWR1726

*NEW*

## 1.5W Rated Output Power UNREGULATED DC-TO-DC CONVERTER Medical-Isolation Grade

### FEATURES

- 8000V ISOLATION TEST VOLTAGE
- NO EXTERNAL PARTS REQUIRED
- SYNCHRONIZABLE
- REMOTE ON/OFF
- LOW-BARRIER CAPACITANCE

### APPLICATIONS

- PATIENT-MONITORING EQUIPMENT
- INDUSTRIAL-PROCESS EQUIPMENT
- DATA ACQUISITION
- TEST EQUIPMENT
- PORTABLE EQUIPMENT

### DESCRIPTION

The PWR1726 is a single-channel, dual-output DC/DC converter designed for medical applications or those applications where high-isolation voltage and low-barrier capacitance are critical for system reliability and integrity.

Calculated mean-time-to-failure (MTTF) is in excess of 100 years at an ambient temperature of +125°C and at rated output power. The performance of the PWR1726 is not derated over its entire specified temperature range of -25°C to +85°C.

Synchronization of the PWR1726 may be accom-

plished simply by connecting the Sync pin of one unit to the Sync pin of another unit. In this manner, up to eight converters may be ganged together.

The PWR1726 provides a plus and minus output voltage that is approximately equal to the magnitude of the input voltage. The PWR1726 operates over an input voltage range of 7VDC to 18VDC.

Each PWR1726 is tested in compliance with UL544, VDE750, and CSAC22.2 dielectric withstand specifications. In addition, all minimum and maximum specifications are 100% tested.

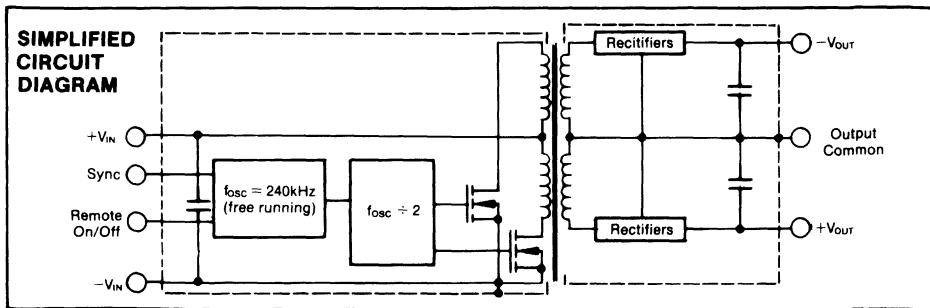

International Airport Industrial Park • P.O. Box 11400 • Tucson, Arizona 85734 • Tel.: (602) 746-1111 • Twx: 910-952-1111 • Cable: BBRCORP • Telex: 86-6481

PDS-788

# SPECIFICATIONS

## ELECTRICAL

At  $T_A = +25^\circ\text{C}$ ,  $V_{IN} = 15\text{VDC}$ ,  $I_{LOAD} = \pm 50\text{mA}$  and in free-running mode unless otherwise noted.

PARAMETER	CONDITIONS	PWR1726			UNITS
		MIN	TYP	MAX	
<b>INPUT</b>					
Rated Voltage <sup>(1)</sup>			15		VDC
Voltage Range		7	30	18	VDC
Input Current	$I_{LOAD} = 0$		145	165	mA
	$I_{LOAD} = \text{Rated Load}$		115		mA
Ripple Current	$I_{LOAD} = \text{Rated Load}$		15		mAp-p
<b>ISOLATION</b>					
Voltage Rated Continuous		3500			Vrms
AC, 60Hz		5000			VDC
DC		8000			Vpk
Test Voltage	60sec, 60Hz		$10^{12}$		$\Omega$
Resistance			10		pF
Capacitance	$V_{ISO} = 240\text{VAC}, 60\text{Hz}$		1	2	$\mu\text{A}$
Leakage Current					
<b>OUTPUT</b>					
Rated Voltage <sup>(1)</sup>	$I_{LOAD} = \text{Rated Load}$	$\pm 14.25$	$\pm 15$	$\pm 15.75$	VDC
Voltage Range	$I_{LOAD} = \text{Rated Load}$	$\pm 16.0$	$\pm 16.5$	$\pm 18.0$	VDC
	$I_{LOAD} = 0\text{mA}$		$\pm 50$		mA
Rated Current	Balanced Loads	0		$\pm 90$	mA
Current Range	Balanced Loads	0		180	mA
	Single Ended				mA
Line Regulation	$7\text{VDC} < V_{IN} < 18\text{VDC}$		1.16		mV/mV
Load Regulation	No Load $< I_{OUT} < \pm 50\text{mA}$			0.3	%/mA
Ripple Voltage	BW = DC to 10MHz				mVp-p
	$I_{LOAD} = 0$		15		mVp-p
	$I_{LOAD} = \text{Rated Load}$		50		mVp-p
<b>GENERAL</b>					
MTTF	Calculated per MIL-HDBK-217 Rev. E Ground, Benign $25^\circ\text{C}$		$1.2 \times 10^6$		hrs
Switching Frequency			120		kHz
<b>TEMPERATURE</b>					
Specification		-25		+85	$^\circ\text{C}$
Operating		-40		+100	$^\circ\text{C}$
Storage		-55		+125	$^\circ\text{C}$

NOTE: (1) Other input and output voltages available upon request.

## ABSOLUTE MAXIMUM RATINGS

Input Voltage	18VDC
Output Short-Circuit Duration	Continuous
Internal Power Dissipation	2W
Lead Temperature (soldering, 10sec)	+300 $^\circ\text{C}$
Junction Temperature	+150 $^\circ\text{C}$
Package Thermal Resistance (Junction-to-Ambient, $\theta_{JA}$ )	65 $^\circ\text{C/W}$

## PIN CONFIGURATION

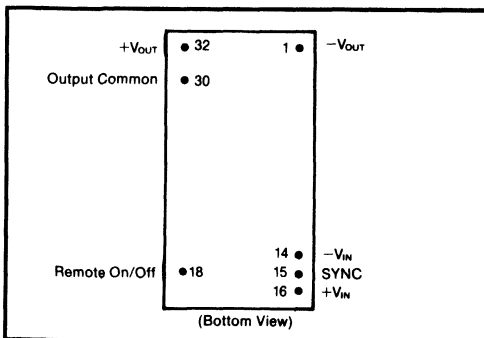

## MECHANICAL

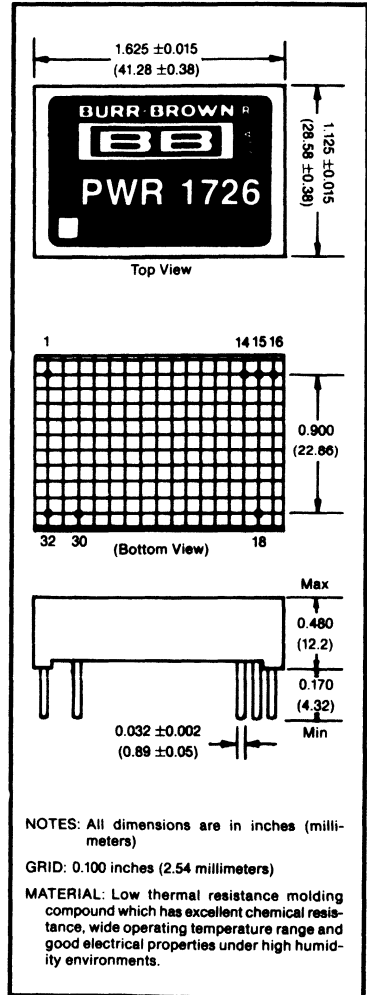

# TYPICAL PERFORMANCE CURVES

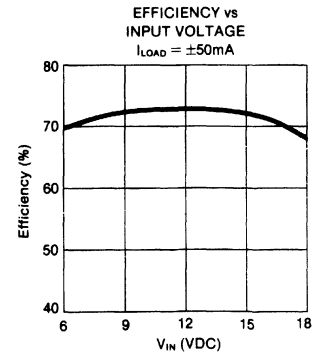
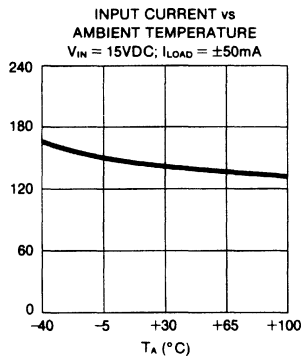
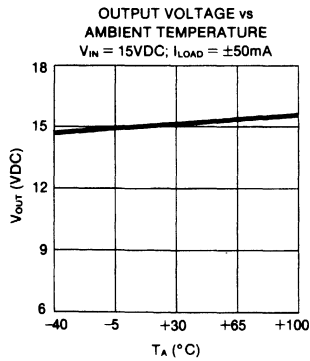
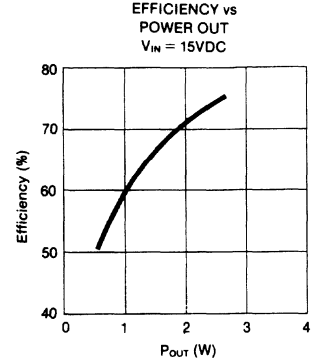
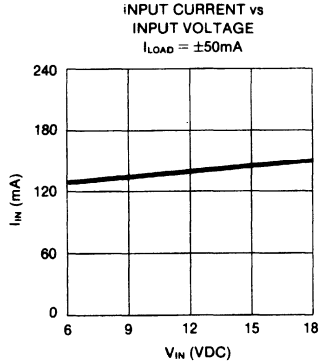
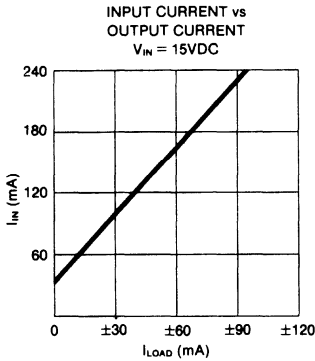
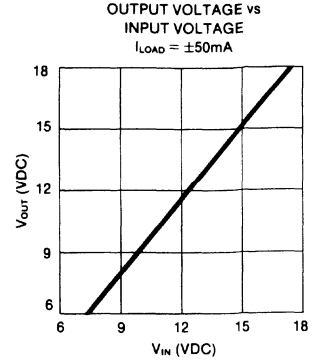
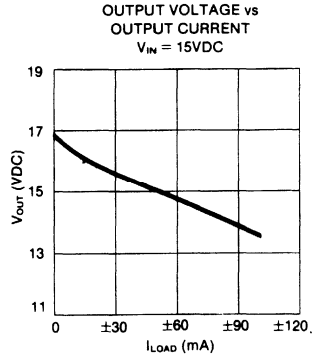
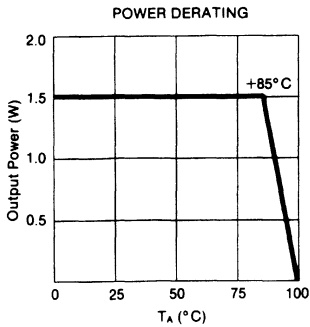



## PWR5104 PWR5105

### 9W Rated Output Power REGULATED DC-TO-DC CONVERTER

#### FEATURES

- LOW COST
- LOW NOISE
- LINEAR OUTPUT REGULATION
- WIDE OPERATING TEMPERATURE RANGE:  
-40°C TO +100°C
- ±12VDC AND ±15VDC OUTPUTS
- INPUT AND OUTPUT FILTERING
- SIX-SIDED SHIELDING
- BARRIER LEAKAGE CURRENT 100% TESTED AT 240VAC

#### DESCRIPTION

The PWR5104 and PWR5105 offer respectively ±12VDC and ±15VDC outputs of regulated 9W power driven from your +5V system buss. These units are designed for use in such diverse applications as process control, telecommunications, portable equipment, medical systems, airborne and shipboard electronic circuits, and automatic test equipment.

The PWR5104 and PWR5105 offer a low cost alternative to the models currently in the market. In addition these models utilize high frequency switch

ing in order to maintain a low EMI and RFI environment. Both models incorporate input and output filtering along with six-sided shielding to keep unwanted noise from your circuit.

Surface-mounted devices and manufacturing processes are used in the PWR5104 and PWR5105 to give you a device which is more environmentally rugged than most DC-to-DC converters. These manufacturing and design technologies also give superior isolation voltage.

#### CONNECTION DIAGRAM

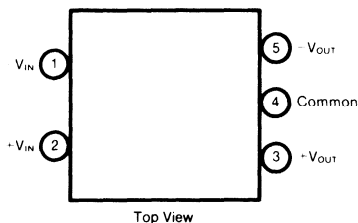

#### ORDERING INFORMATION

Device Family \_\_\_\_\_ PWR 510X/G  
 PWR indicates DC/DC converter  
 Model Number \_\_\_\_\_  
 Selected from table of Electrical Characteristics  
 Reliability Screening \_\_\_\_\_  
 No designator indicates standard manufacturing processing  
 /G indicates Level I screening—burn-in only  
 /T indicates Level II screening—stabilization bake, temperature cycling, and burn-in

# SPECIFICATIONS

## ELECTRICAL

Specifications typical at  $T_A = +25^\circ\text{C}$ , nominal input voltage and rated output current unless otherwise noted.

PARAMETER	CONDITIONS	PWR5104/5105			UNITS
		MIN	TYP	MAX	
<b>INPUT</b>					
Nominal Voltage		4.75	5.00	5.25	VDC
Voltage Range <sup>(1)</sup>					VDC
Input Current	No load		60		mA
Input Current	Rated load		2400	2570	mA
Ripple Current	At rated load		5		mA, p-p
<b>OUTPUT</b>					
PWR5104 Rated Voltage			$\pm 12$		VDC
PWR5105 Rated Voltage			$\pm 15$		VDC
Accuracy			$\pm 0.5$	$\pm 1.0$	%
Voltage Balance			$\pm 0.3$		%
Temperature Coefficient	$-25^\circ\text{C}$ to $+85^\circ\text{C}$		$\pm 0.01$		%/ $^\circ\text{C}$
PWR5104 Rated Current		$\pm 375$			mA
PWR5105 Rated Current		$\pm 300$			mA
Ripple and Noise	BW = DC to 10MHz		6	35	mV, p-p
Line Regulation			0.02		%
Load Regulation			0.04		%
Efficiency		70	75		%
<b>ISOLATION</b>					
Rated Voltage		750			VDC
Resistance			10		G $\Omega$
Capacitance			50		pF
Leakage Current	240Vrms, 60Hz			15	$\mu\text{A}$ , rms
<b>GENERAL</b>					
Switching Frequency			50		kHz
<b>TEMPERATURE</b>					
Specification		-25		+85	$^\circ\text{C}$
Operation		-40		+100	$^\circ\text{C}$
Storage		-55		+125	$^\circ\text{C}$

NOTE: (1) Other voltage ranges available. Contact factory.

## ABSOLUTE MAXIMUM RATINGS

Input Voltage.....	110% of nominal
Output Short-Circuit Duration .....	15 seconds
Internal Power Dissipation .....	4.0W
Lead Temperature (soldering, 10 seconds).....	+300 $^\circ\text{C}$
Junction Temperature.....	+150 $^\circ\text{C}$
Package Thermal Resistance, Junction-to-Ambient, $\theta_{JA}$ .....	15 $^\circ\text{C}/\text{W}$

## MECHANICAL

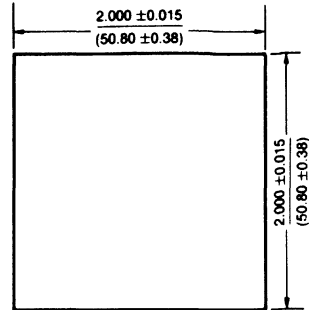

Top View—"A" Package Option

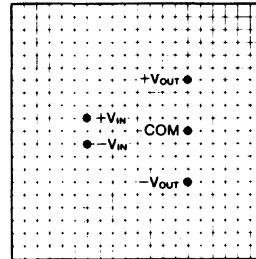

Bottom View—"A" Package Option

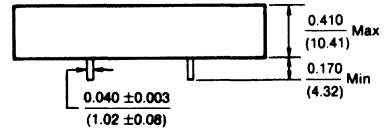

Side View—"A" Package Option

### NOTES:

All dimensions are in inches (millimeters)

GRID: 0.100 inches (2.54 millimeters)

**MATERIAL:** Units are encapsulated in a low thermal resistance molding compound which has excellent chemical resistance, wide operating temperature range, and good electrical properties under high humidity environments. Lead material is brass with a hot-solder-dipped surface to allow ease of solderability.



## TYPICAL PERFORMANCE CURVES

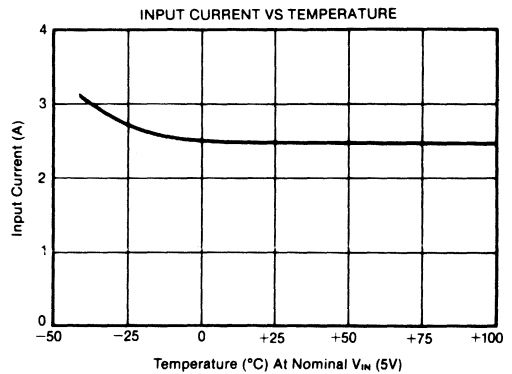
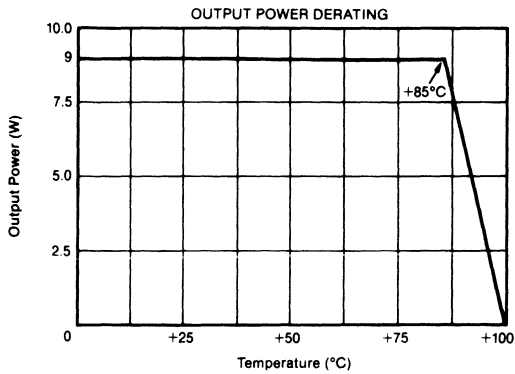
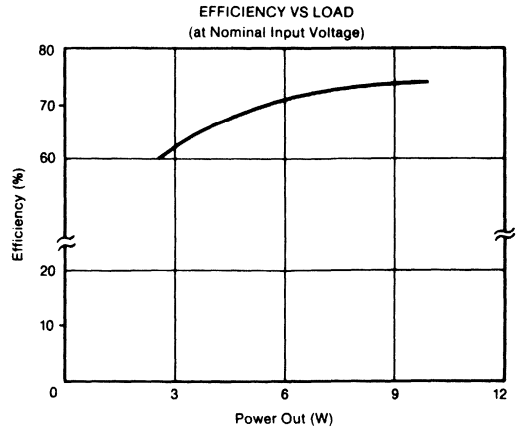
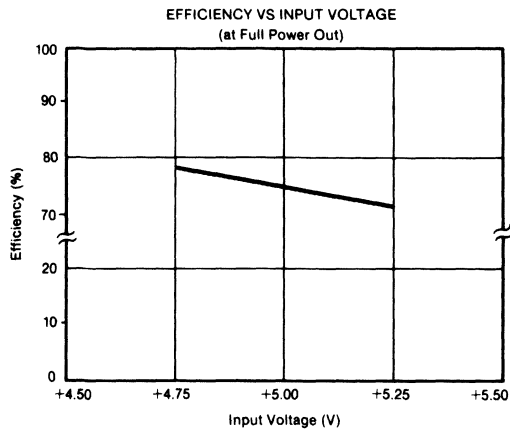



## PWR53XX SERIES SINGLE OUTPUT

*NEW*

AVAILABLE 4TH QTR '88  
ADVANCE INFORMATION  
SUBJECT TO CHANGE

### 15 Watt, 2:1 Input WIDE RANGE DC/DC CONVERTER

#### FEATURES

- 2:1 INPUT VOLTAGE RANGE
- REMOTE ON/OFF
- SHORT-CIRCUIT PROTECTION
- SIX-SIDED SHIELDING
- OVER-VOLTAGE PROTECTION
- PI INPUT AND OUTPUT FILTERING

#### APPLICATIONS

- TELECOMMUNICATIONS EQUIPMENT
- BATTERY POWERED SYSTEMS
- AIRBORNE AND SHIPBOARD ELECTRONICS
- PORTABLE INSTRUMENTATION

#### DESCRIPTION

The PWR53XX Series offers a large selection of regulated 15W DC/DC converter with a wide 2:1 input voltage range. These products are loaded with features such as short-circuit protection, six-sided shielding, remote ON/OFF, and over-voltage protection.

A combination of high-efficiency, remote ON/OFF, and wide input range makes the PWR53XX series ideal for battery powered systems. Other well-suited applications included telecommunications equipment, portable instrumentation, and airborne and shipboard electronics.

The PWR53XX Series is also available in dual and triple outputs to suit almost every requirement. Input ranges of 9-18VDC, 18-36VDC, and 36-72VDC give the designer great flexibility in system powering. Using

PWM regulation allows for efficiencies of 75% to 85%, which along with the remote ON/OFF function helps conserve battery power.

Six-sided shielding suppresses electromagnetic radiation, which could disturb sensitive analog measurements or interfere with system timing signals. Internal PI filters on both input and output lines minimizes the effects of switching noise on the source and loads.

All units utilize surface mount technology for ruggedness and long-term reliability. Conservative design rules were followed, yielding low component stress levels and a high MTTF. These units are designed and built with the same commitment to excellence as our high grade medical power products.

International Airport Industrial Park • Mailing Address: PO Box 11400 • Tucson, AZ 85734 • Street Address: 6730 S. Tucson Blvd. • Tucson, AZ 85706  
Tel: (602) 746-1111 • Twx: 910-952-1111 • Cable: BBRCORP • Telex: 66-6491 • FAX: (602) 889-1510

PDS-873

# SPECIFICATIONS

## ELECTRICAL

At  $T_a = +25^\circ\text{C}$ , Rated Input Voltage, Rated Output Current unless otherwise noted.

PARAMETER	CONDITIONS	MIN	TYP	MAX	UNITS
INPUT Ranges		9		18	VDC
		18		36	VDC
		36		72	VDC
ISOLATION Rated Voltage Resistance		500			VDC
			10		GΩ
OUTPUT Rated Voltages Rated Currents Voltage Accuracy Temperature Coefficient Ripple and Noise Response Time Overvoltage Protection	See Below				VDC
	See Below				mA
				±1.0	%
			±0.02		%/°C
				75	mVp-p
				500	μs
				6.8	VDC
REGULATION Line Load	Lowline to Highline			±0.2	%
	Full load to 1/4 Load			±1.0	%
GENERAL Efficiency Switching Frequency			75		%
			100		kHz

## THERMAL

Specification	-25	+85	°C
Operating	-40	+100	°C
Storage	-55	+150	°C

## REMOTE ON/OFF

Logic Compatibility	CMOS or Open Collector TTL
$E_c$ ON	+5.0VDC or Open Circuit
$E_c$ OFF	+0.4VDC
Shutdown Idle Current	18mA
Control Common	- $V_{IN}$

## ABSOLUTE MAXIMUM RATINGS

Output Short-Circuit Duration	Continuous
Lead Temperature (soldering, 10 sec)	+300°C

## MODEL NUMBERS

MODEL	$V_{IN}$	$V_{OUT}$	$I_{OUT}$
PWR5300	9-18VDC	5VDC	3000mA
PWR5301	9-18VDC	12VDC	1250mA
PWR5302	9-18VDC	15VDC	1000mA
PWR5303	18-36VDC	5VDC	3000mA
PWR5304	18-36VDC	12VDC	1250mA
PWR5305	18-36VDC	15VDC	1000mA
PWR5306	36-72VDC	5VDC	3000mA
PWR5307	36-72VDC	12VDC	1250mA
PWR5308	36-72VDC	15VDC	1000mA

## MECHANICAL

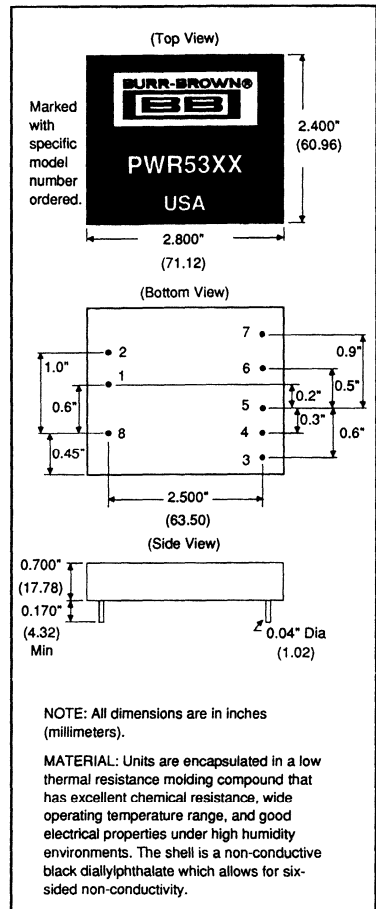

## PIN CONNECTIONS

SINGLES	
PIN	FUNCTION
1	+ $V_{IN}$
2	- $V_{IN}$
3	No Pin
4	No Pin
5	No Pin
6	+ $V_{OUT}$
7	- $V_{OUT}$
8	Remote On/Off



## PWR53XX SERIES DUAL OUTPUT

*NEW*

AVAILABLE 4TH QTR '88  
ADVANCE INFORMATION  
SUBJECT TO CHANGE

### 15 Watt, 2:1 Input WIDE RANGE DC/DC CONVERTER

#### FEATURES

- 2:1 INPUT VOLTAGE RANGE
- REMOTE ON/OFF
- SHORT-CIRCUIT PROTECTION
- SIX-SIDED SHIELDING
- OVER-VOLTAGE PROTECTION
- PI INPUT AND OUTPUT FILTERING

#### APPLICATIONS

- TELECOMMUNICATIONS EQUIPMENT
- BATTERY-POWERED SYSTEMS
- AIRBORNE AND SHIPBOARD ELECTRONICS
- PORTABLE INSTRUMENTATION

#### DESCRIPTION

The PWR53XX Series offers a large selection of regulated 15W DC/DC converters with a wide 2:1 input voltage range. These products are loaded with features such as short-circuit protection, six-sided shielding, remote ON/OFF, and over-voltage protection.

A combination of high-efficiency, remote ON/OFF, and wide input range makes the PWR53XX series ideal for battery powered systems. Other well-suited applications include telecommunications equipment, portable instrumentation, and airborne and shipboard electronics.

The PWR53XX Series is also available in single and triple outputs to suit almost every requirement. Input ranges of 9-18VDC, 18-36VDC, and 36-72VDC give the designer great flexibility in system powering. Using

PWM regulation allows for efficiencies of 75% to 85%, which along with the remote ON/OFF function helps conserve battery power.

Six-sided shielding suppresses electromagnetic radiation, that could disturb sensitive analog measurements or interfere with system timing signals. Internal PI filters on both input and output lines minimizes the effects of switching noise on the source and loads.

All units utilize surface mount technology for ruggedness and long-term reliability. Conservative design rules were followed, yielding low component stress levels and a high MTTF. These units are designed and built with the same commitment to excellence as our high-grade medical power products.

International Airport Industrial Park • Mailing Address: PO Box 11400 • Tucson, AZ 85734 • Street Address: 6730 S. Tucson Blvd. • Tucson, AZ 85706  
Tel: (602) 746-1111 • Twx: 910-952-1111 • Cable: BBRCORP • Telex: 66-6491 • FAX: (602) 889-1510

PDS-886

# SPECIFICATIONS

## ELECTRICAL

At  $T_A = +25^\circ\text{C}$ , Rated Input Voltage, Rated Output Current unless otherwise noted.

PARAMETER	CONDITIONS	MIN	TYP	MAX	UNITS
INPUT Ranges		9		18	VDC
		18		36	VDC
		36		72	VDC
ISOLATION Rated Voltage Resistance		500	10		VDC GΩ
OUTPUT Rated Voltages Rated Currents Voltage Accuracy Temperature Coefficient Ripple and Noise Response Time	See Below			±1.0	VDC mA % %/°C mVp-p μs
	See Below				
	BW = DC to 10MHz To within ±1.0% 25% step change in load		±0.01		
				75	
				500	
REGULATION Line Load	Lowline to Highline Full load to 1/4 Load			±0.2 ±1.0	% %
GENERAL Efficiency Switching Frequency			80 100		% kHz

## THERMAL

Specification	-25		+85	°C
Operating	-40		+100	°C
Storage	-55		+150	°C

## REMOTE ON/OFF

Logic Compatibility .....	CMOS or Open Collector TTL
$E_c$ ON .....	+5.0VDC or Open Circuit
$E_c$ OFF .....	+0.4VDC
Shutdown Idle Current .....	18mA
Control Common .....	- $V_{IN}$

## ABSOLUTE MAXIMUM RATINGS

Output Short-Circuit Duration .....	Continuous
Lead Temperature (soldering, 10 sec) .....	+300°C

## MODEL NUMBERS

MODEL	$V_{IN}$	$V_{OUT}$	$I_{OUT}$
PWR5309	9-18VDC	±5VDC	1500mA
PWR5310	9-18VDC	±12VDC	625mA
PWR5311	9-18VDC	±15VDC	500mA
PWR5312	18-36VDC	±5VDC	1500mA
PWR5313	18-36VDC	±12VDC	625mA
PWR5314	18-36VDC	±15VDC	500mA
PWR5315	36-72VDC	±5VDC	1500mA
PWR5316	36-72VDC	±12VDC	625mA
PWR5317	36-72VDC	±15VDC	500mA

## MECHANICAL

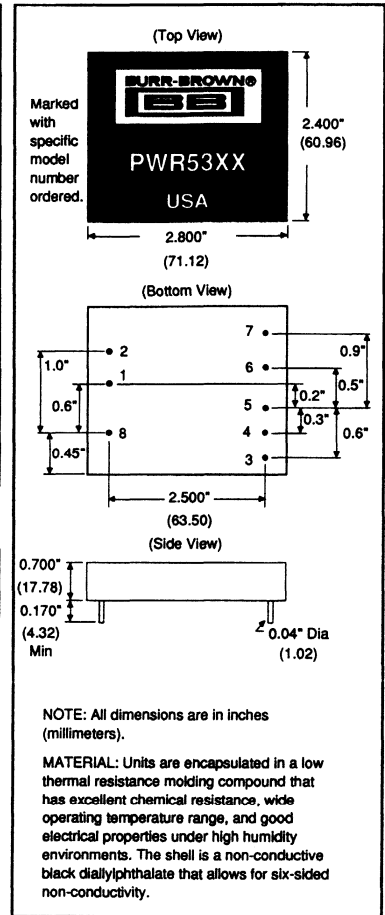

## PIN CONNECTIONS

DUALS	
PIN	FUNCTION
1	+ $V_{IN}$
2	- $V_{IN}$
3	+ $V_{OUT}$
4	Common
5	- $V_{OUT}$
6	No Pin
7	No Pin
8	Remote On/Off



## PWR53XX SERIES TRIPLE OUTPUT

*NEW*

AVAILABLE 1ST QTR '89  
ADVANCE INFORMATION  
SUBJECT TO CHANGE

### 15 Watt, 2:1 Input WIDE RANGE DC/DC CONVERTER

#### FEATURES

- 2:1 INPUT VOLTAGE RANGE
- REMOTE ON/OFF
- SHORT-CIRCUIT PROTECTION
- SIX-SIDED SHIELDING
- OVER-VOLTAGE PROTECTION
- PI INPUT AND OUTPUT FILTERING

#### APPLICATIONS

- TELECOMMUNICATIONS EQUIPMENT
- BATTERY-POWERED SYSTEMS
- AIRBORNE AND SHIPBOARD ELECTRONICS
- PORTABLE INSTRUMENTATION

#### DESCRIPTION

The PWR53XX Series offers a large selection of regulated 15W DC/DC converters with a wide 2:1 input voltage range. These products are loaded with features such as short-circuit protection, six-sided shielding, remote ON/OFF, and over-voltage protection.

A combination of high-efficiency, remote ON/OFF, and wide input range makes the PWR53XX series ideal for battery powered systems. Other well-suited applications include telecommunications equipment, portable instrumentation, and airborne and shipboard electronics.

The PWR53XX Series is also available in single and dual outputs to suit almost every requirement. Input ranges of 9-18VDC, 18-36VDC, and 36-72VDC give the designer great flexibility in system powering. Using

PWM regulation allows for efficiencies of 75% to 85%, which along with the remote ON/OFF function helps conserve battery power.

Six-sided shielding suppresses electromagnetic radiation, that could disturb sensitive analog measurements or interfere with system timing signals. Internal PI filters on both input and output lines minimizes the effects of switching noise on the source and loads.

All units utilize surface mount technology for ruggedness and long-term reliability. Conservative design rules were followed, yielding low component stress levels and a high MTTF. These units are designed and built with the same commitment to excellence as our high-grade medical power products.

International Airport Industrial Park • Mailing Address: PO Box 11400 • Tucson, AZ 85734 • Street Address: 6730 S. Tucson Blvd. • Tucson, AZ 85706  
Tel: (602) 746-1111 • Twx: 910-952-1111 • Cable: BBRCORP • Telex: 66-6491 • FAX: (602) 889-1510

PDS-887

# SPECIFICATIONS

## ELECTRICAL

At  $T_a = +25^\circ\text{C}$ , Rated Input Voltage, Rated Output Current unless otherwise noted.

PARAMETER	CONDITIONS	MIN	TYP	MAX	UNITS
INPUT Ranges		9		18	VDC
		18		36	VDC
		36		72	VDC
ISOLATION Rated Voltage Resistance		500			VDC
			10		GΩ
OUTPUT Rated Voltages Rated Currents Voltage Accuracy	See Below				VDC
	See Below				mA
	5VDC Outputs		±2		%
	12 & 15VDC Outputs		±3		%
Temperature Coefficient Ripple and Noise	BW = DC to 10MHz		±0.04		%/°C
				75	mVp-p
REGULATION Line Load	Lowline to Highline Full load to 1/4 Load			±1.0	%
				±5	%
GENERAL Efficiency Switching Frequency			80		%
			100		kHz

## THERMAL

Specification	-25	+85	°C
Operating	-40	+100	°C
Storage	-55	+150	°C

## REMOTE ON/OFF

Logic Compatibility	CMOS or Open Collector TTL
$E_c$ ON	+5.0VDC or Open Circuit
$E_c$ OFF	+0.4VDC
Shutdown Idle Current	18mA
Control Common	- $V_{IN}$

## ABSOLUTE MAXIMUM RATINGS

Output Short-Circuit Duration	Continuous
Lead Temperature (soldering, 10 sec)	+300°C

## MODEL NUMBERS

MODEL	$V_{IN}$	$V_{OUT}$	$I_{OUT}$
PWR5318	9-18VDC	5±12VDC	1500±310mA
PWR5319	9-18VDC	5±15VDC	1500±250mA
PWR5320	9-18VDC	5/12-5VDC	1500/310/-500mA
PWR5321	18-36VDC	5±12VDC	1500±310mA
PWR5322	18-36VDC	5±15VDC	1500±250mA
PWR5323	18-36VDC	5/12-5VDC	1500/310/-500mA
PWR5324	36-72VDC	5±12VDC	1500±310mA
PWR5325	36-72VDC	5±15VDC	1500±250mA
PWR5326	36-72VDC	5/12-5VDC	1500/310/-500mA

## MECHANICAL

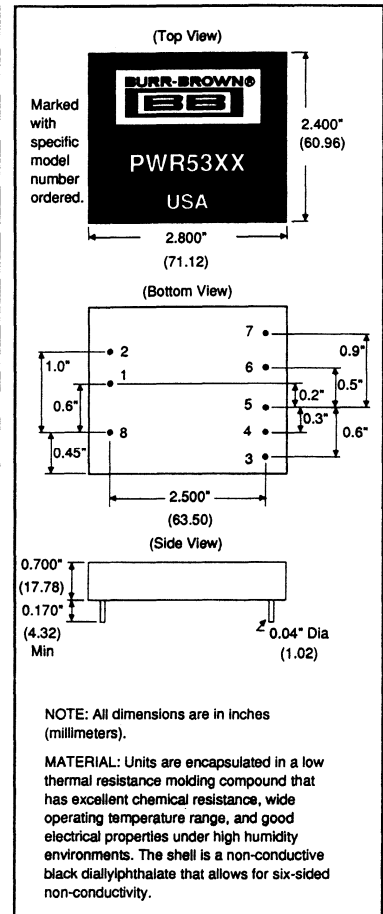

## PIN CONNECTIONS

TRIPLE	
PIN	FUNCTION
1	+ $V_{IN}$
2	- $V_{IN}$
3	+ $V_{OUT}$
4	Common
5	- $V_{OUT}$
6	+5VDC Out
7	No Pin
8	Remote On/Off



PWR59XX

AVAILABLE 4TH QTR '88  
ADVANCE INFORMATION  
SUBJECT TO CHANGE

---



---

***NEW***

---



---

## 24-Pin DIP, REGULATED DC/DC CONVERTER

### FEATURES

- 24-PIN DIP PACKAGE
- FULLY REGULATED OUTPUTS
- INTERNAL INPUT AND OUTPUT FILTERING
- 20mVp-p RIPPLE AND NOISE WITH NO EXTERNAL COMPONENTS
- MTTF GREATER THAN 2 MILLION HOURS AT +25°C
- SHORT-CIRCUIT PROTECTION
- BUILT-IN STANDOFFS

### APPLICATIONS

- HIGH-DENSITY PC BOARDS
- COMPUTER PERIPHERALS
- LAN POWER
- PORTABLE EQUIPMENT

### DESCRIPTION

The PWR59XX Series offers a broad line of low-cost, high-performance, regulated, single and dual outputs DC/DC converters in a 24-pin DIP package. These miniature converters offer better performance in industry-standard package and pin-out at lower cost. The PWR59XX Series is internally filtered to give an output noise and ripple specification of 20mVp-p. No external parts are necessary to obtain this performance.

Surface mounted components and void free, hard-cast epoxy allow for superior reliability, excellent thermal dissipation, and an extended temperature range of +85°C at no extra cost. The calculated MTTF (per MIL-HDBK-217 Rev. E, circuit stress-analysis method, ground benign) is 2.725 million hours for the PWR5905 at +25°C.

The PWR59XX Series is ideal for use on high-density PC boards where isolated, regulated, low ripple power is needed. An input PI filter is standard on all models, eliminating the need for external filtering, which uses precious board space. The standoffs allow for PC board cleaning, helping preserve isolation. They also allow for visual inspection of solder joints from above.

The 9VDC output units can supply power to operate LAN circuits in a standard package. The isolation and regulation make the PWR59XX well suited for this application as well as digital-to-analog and analog-to-digital (DAC and ADC) conversion circuits. The short-circuit protection gives safety to the unit for prototyping and production solder-bridges.

International Airport Industrial Park • Mailing Address: PO Box 11400 • Tucson, AZ 85734 • Street Address: 6730 S. Tucson Blvd. • Tucson, AZ 85706  
Tel: (602) 746-1111 • Twx: 910-952-1111 • Cable: BBRCORP • Telex: 66-6491 • FAX: (602) 889-1510

PDS-879



# SPECIFICATIONS

## ELECTRICAL

Specifications at  $T_a = +25^\circ\text{C}$ , Rated Input Voltage, Rated Output Current unless otherwise noted.

PARAMETER	CONDITIONS	MIN	TYP	MAX	UNITS
INPUT Ranges		4.5	5	5.5	VDC
		10.8	12	13.2	VDC
		21.6	24	26.4	VDC
		43.2	48	52.8	VDC
Ripple Current	$V_{in}$ = Nominal		50		mAp-p
ISOLATION					
Rated Voltage		500			VDC
Resistance			10		GR
OUTPUT					
Rated Voltages	See Below				VDC
Rated Currents	See Below			$\pm 3$	mA
Voltage Accuracy	5VDC Outputs				%
Ripple and Noise	BW = DC to 10MHz No External Parts			20	mVp-p
REGULATION					
Line	Lowline to Highline		$\pm 0.3$		%
Load	1/4 Load to Full Load		0.4		%
GENERAL					
Switching Frequency			100		kHz

## THERMAL

PARAMETER	CONDITIONS	MIN	TYP	MAX	UNITS
Specification		-25		+85	$^\circ\text{C}$
Operating		-40		+100	$^\circ\text{C}$
Storage		-55		+150	$^\circ\text{C}$

## ABSOLUTE MAXIMUM RATINGS

Output Short-Circuit Duration ..... Continuous  
Lead Temperature (soldering, 10 sec) ..... +300 $^\circ\text{C}$

## MODEL NUMBERS

### Duals

MODEL	$V_{in}$	$V_{out}$	$I_{out}$	MODEL	$V_{in}$	$V_{out}$	$I_{out}$
PWR5900	5VDC	5VDC	200mA	PWR5914	24VDC	5VDC	200mA
PWR5901	5VDC	9VDC	111mA	PWR5915	24VDC	9VDC	111mA
PWR5902	5VDC	12VDC	83mA	PWR5916	24VDC	12VDC	83mA
PWR5903	5VDC	15VDC	66mA	PWR5917	24VDC	15VDC	66mA
PWR5904	5VDC	$\pm 5$ VDC	$\pm 200$ mA	PWR5918	24VDC	$\pm 5$ VDC	$\pm 200$ mA
PWR5905	5VDC	$\pm 12$ VDC	$\pm 83$ mA	PWR5919	24VDC	$\pm 12$ VDC	$\pm 83$ mA
PWR5906	5VDC	$\pm 15$ VDC	$\pm 66$ mA	PWR5920	24VDC	$\pm 15$ VDC	$\pm 66$ mA
PWR5907	12VDC	5VDC	200mA	PWR5921	48VDC	5VDC	200mA
PWR5908	12VDC	9VDC	111mA	PWR5922	48VDC	9VDC	111mA
PWR5909	12VDC	12VDC	83mA	PWR5923	48VDC	12VDC	83mA
PWR5910	12VDC	15VDC	66mA	PWR5924	48VDC	15VDC	66mA
PWR5911	12VDC	$\pm 5$ VDC	$\pm 200$ mA	PWR5925	48VDC	$\pm 5$ VDC	$\pm 200$ mA
PWR5912	12VDC	$\pm 12$ VDC	$\pm 83$ mA	PWR5926	48VDC	$\pm 12$ VDC	$\pm 83$ mA
PWR5913	12VDC	$\pm 15$ VDC	$\pm 66$ mA	PWR5927	48VDC	$\pm 15$ VDC	$\pm 66$ mA

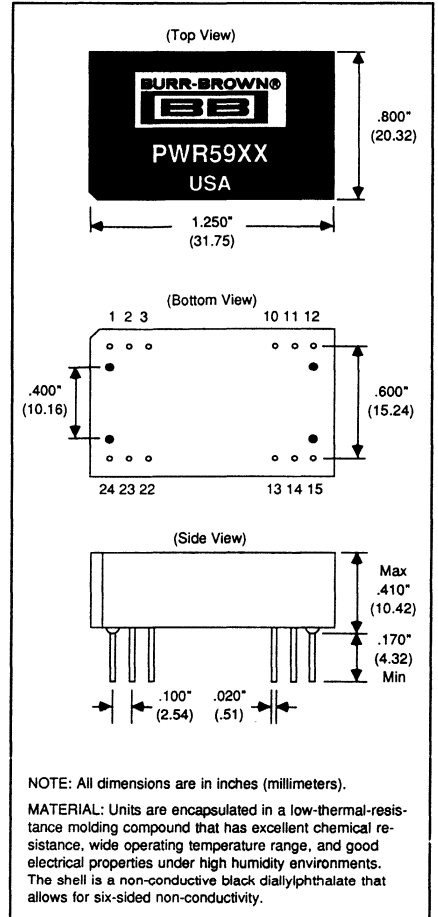

## PIN CONNECTIONS

PIN	Singles	Duals
	FUNCTION	FUNCTION
1	+ $V_{in}$	+ $V_{in}$
2	NC	- $V_{out}$
3	NC	Common
10	- $V_{out}$	Common
11	+ $V_{out}$	+ $V_{out}$
12	- $V_{out}$	- $V_{in}$
13	- $V_{in}$	- $V_{in}$
14	+ $V_{out}$	+ $V_{in}$
15	- $V_{out}$	Common
22	NC	Common
23	NC	- $V_{out}$
24	+ $V_{in}$	+ $V_{in}$



## PWR62XX SERIES

---



---

*NEW*

---



---

## -5.2VDC Output, ECL Power Supply 5.2W REGULATED DC/DC CONVERTER

### FEATURES

- -5.2 VDC OUTPUT
- LINEAR OUTPUT REGULATION
- WIDE OPERATING TEMPERATURE RANGE: -40°C to +100°C
- INPUT AND OUTPUT FILTERING
- SIX-SIDED SHIELDING
- 1000mA OUTPUT CURRENT
- 5, 12, 15, 24, 28 & 48VDC INPUT VOLTAGES
- ISOLATED

### APPLICATIONS

- ECL LOGIC SUPPLY
- HIGH-SPEED ADC
- COMPUTERS

### DESCRIPTION

The PWR62XX Series offers a selection of regulated 5.2W DC/DC converters for use in power ECL systems. The -5.2VDC output and various input voltages are fully isolated, allowing the designer flexibility in grounding and polarity configurations.

This series is the only one currently offered designed to give the -5.2VDC for ECL logic with no external trimming components. This reduces spare, labor, and costs in the end product. The PWR62XX Series has a low 15mVp-p typical output ripple and noise specification. No external parts are necessary to obtain this performance. Low noise insures system integrity and

solves problems before they occur. The absence of extra external filtering components further reduces total costs.

Surface-mounted devices and manufacturing processes are used in the PWR62XX to give the user a device more environmentally rugged than most converters. Void-free, hard-cast epoxy allows for excellent thermal dissipation and superior reliability. All models incorporate input and output filtering along with six-sided shielding to keep unwanted noise from your sensitive circuitry.

International Airport Industrial Park • Mailing Address: PO Box 11400 • Tucson, AZ 85734 • Street Address: 6730 S. Tucson Blvd. • Tucson, AZ 85706  
Tel: (602) 746-1111 • Twx: 910-952-1111 • Cable: BBRCORP • Telex: 66-6491 • FAX: (602) 889-1510

PDS-891

# SPECIFICATIONS

## ELECTRICAL CHARACTERISTICS

Specifications at  $T_A = +25^\circ\text{C}$ , Rated Input Voltage, Rated Output Current unless otherwise specified.

PARAMETER	CONDITIONS	MIN	TYP	MAX	UNITS
<b>INPUT</b> Voltage	PWR6200	4.65	5.0	6.0	VDC
	PWR6201	11.0	12.0	15.0	VDC
	PWR6202	13.9	15.0	17.0	VDC
	PWR6203	21.0	24.0	27.0	VDC
	PWR6204	25.0	28.0	31.0	VDC
	PWR6205	44.5	48.0	53.0	VDC
Reflected Ripple Current			10		mAp-p
<b>ISOLATION</b> Rated Voltage Resistance Capacitance Leakage Current		500			VDC
			10		GΩ
			150		pF
	$V_{so} = 240\text{VAC}, 60\text{Hz}$			25	μArms
<b>OUTPUT</b> Rated Voltage Voltage Accuracy Temperature Coefficient Rated Current Rated Power Ripple and Noise			-5.2		VDC
				±1	%
			±0.01		%/°C
			1000		mA
			5.2		W
	$\text{BW} = \text{DC to } 10\text{MHz}$			15	
<b>REGULATION</b> Line Load	High Line to Low Line		±0.04		%
	Full Load to No Load		0.06		%
<b>GENERAL</b> Efficiency Switching Frequency MTTF <sup>(1)</sup>			65		%
			60		kHz
			$1.0 \times 10^4$		hours

## MECHANICAL

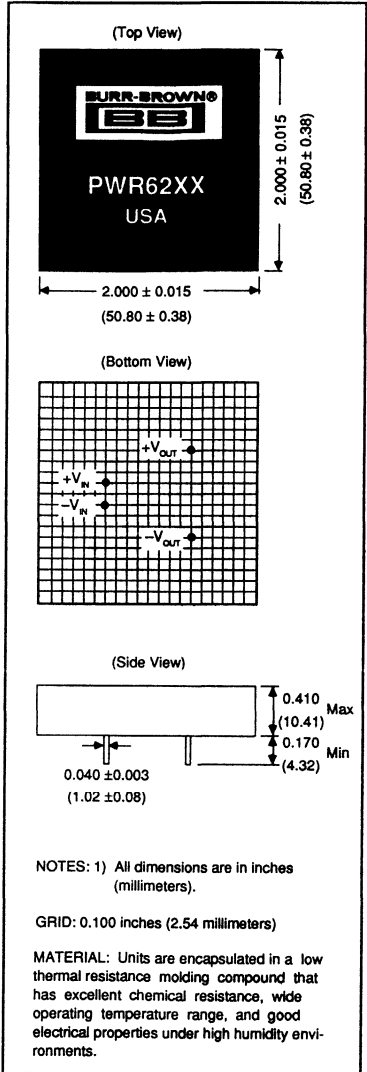

## ORDERING INFORMATION

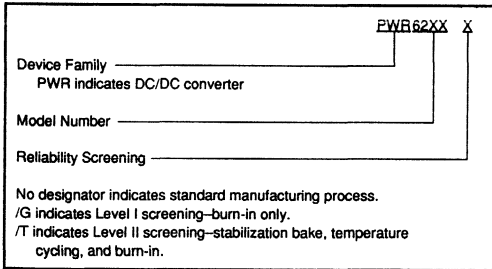

## THERMAL CHARACTERISTICS

PARAMETER	MIN	TYP	MAX	UNITS
Specifications	-25		+85	°C
Operating	-40		+100	°C
Storage	-55		+125	°C
Package Thermal Resistance (Junction-to-Ambient)		15		°C/W

## ABSOLUTE MAXIMUM RATINGS

Input Voltage	6V
Output Short-Circuit Duration	15 min
Internal Power Dissipation	4.0W
Lead Temperature (Soldering, 10sec)	+300°C
Junction Temperature	+150°C



**PWS725**  
**PWS726**

## Isolated, Unregulated DC/DC CONVERTERS

### FEATURES

- ISOLATED  $\pm 7$  TO  $\pm 18$ VDC OUTPUT FROM SINGLE 7 TO 18VDC SUPPLY
- $\pm 15$ mA OUTPUT AT RATED VOLTAGE ACCURACY
- HIGH ISOLATION VOLTAGE  
PWS725: 1500Vrms  
PWS726: 3500Vrms
- LOW LEAKAGE CAPACITANCE: 9pF
- LOW LEAKAGE CURRENT: 2 $\mu$ A, max, at 240VAC 50/60Hz
- HIGH RELIABILITY DESIGN
- AVAILABLE WITH OUTPUT SYNCHRONIZATION SIGNAL FOR USE WITH ISO120 AND ISO121

- PROTECTED AGAINST OUTPUT FAULTS
- COMPACT
- LOW COST
- EASY TO APPLY—FEW EXTERNAL PARTS

### APPLICATIONS

- MEDICAL EQUIPMENT
- INDUSTRIAL PROCESS EQUIPMENT
- TEST EQUIPMENT
- DATA ACQUISITION

### DESCRIPTION

The PWS725 and PWS726 convert a single 7 to 18VDC input to bipolar voltages of the same value as the input voltage. The converters are capable of providing  $\pm 15$ mA at rated voltage accuracy and up to  $\pm 40$ mA without damage. (See Output Current Rating.)

The PWS725 and PWS726 converters provide reliable, engineered solutions where isolated power is required in critical applications. The high isolation voltage rating is achieved through use of a specially-designed transformer and physical spacing. An additional high dielectric-strength, low leakage transformer coating increases the isolation rating of the PWS726.

Reliability and performance are designed in. The bifilar wound, wirebonded transformer simultaneously provides lower output ripple than competing designs, and a higher performance/cost ratio. The

soft-start oscillator/driver design assures full operation of the oscillator before either MOSFET driver turns on, protects the switches, and eliminates high inrush currents during turn-on. Input current sensing protects both the converter and the load from possible thermal damage during a fault condition.

Special design features make these converters especially easy to apply. The compact size allows dense circuit layout while maintaining critical isolation requirements. The Input Sync connection allows frequency synchronization of multiple converters. The Output Sync (PWS725A and PWS726A only) is available to synchronize ISO120 and ISO121 isolation amplifiers. The Enable input allows control over output power in instances where shutdown is desired to conserve power, such as in battery-powered equipment, or where sequencing of power turn-on/turn-off is desired.

# SPECIFICATIONS

## ELECTRICAL

T<sub>A</sub> = +25°C, C<sub>i</sub> = 1.0μF ceramic, V<sub>IN</sub> = 15VDC, operating frequency = 800kHz, V<sub>OUT</sub> = ±15VDC, C<sub>IN</sub> = 1.0μF ceramic, I<sub>OUT</sub> = ±15mA, unless otherwise noted.

PARAMETERS	CONDITIONS	PWS725/725A			PWS726/726A			UNITS
		MIN	TYP	MAX	MIN	TYP	MAX	
<b>INPUT</b>								
Rated Voltage		7	15	18	*	*	*	VDC
Input Voltage Range								VDC
Input Current	I <sub>o</sub> = ±15mA		77			*	*	mA
Input Current Ripple	No external filtering		150			*	*	mAp-p
	L-C input filter, L <sub>IN</sub> = 100μH, C <sub>IN</sub> = 1μF <sup>(1)</sup>		5			*	*	mAp-p
	C only, C <sub>IN</sub> = 1μF		60			*	*	mAp-p
<b>ISOLATION</b>								
Test Voltages	Input to output, 10 seconds	4000			8000			VDC
	Input to output, 60 seconds, minimum	1500			3500			Vrms
Rated Voltage	Input to output, continuous, AC 60Hz			1500			3500	Vrms
	Input to output, continuous DC			2121			4950	VDC
Isolation Impedance	Input to output		10 <sup>12</sup> Ω			*	*	Ω/pF
Leakage Current	Input to output, 240Vrms, 60Hz		1.2	2.0		*	*	μA
<b>OUTPUT</b>								
Rated Output Voltage		14.25	15.00	15.75	*	*	*	VDC
Output Current	Balanced loads		15.0	40		*	*	mA
	Single-ended			80		*	*	mA
	Balanced loads, ±10mA < I <sub>OUT</sub> < ±40mA			0.4		*	*	%/mA
Load Regulation	No external capacitor		60			*	*	mVp-p
Ripple Voltage (400kHz)	L <sub>o</sub> = 10μH, C <sub>o</sub> = 1μF (Figure 1)		10			*	*	mVp-p
	L <sub>o</sub> = 0μH, C <sub>o</sub> filter only				See Performance Curves			
Output Switching Noise	L <sub>o</sub> = 10μH, C <sub>o</sub> = 1.0μF		1			*	*	mVp-p
Output Capacitive Load	L <sub>o</sub> = 100μH, C filter			10		*	*	μF
	C filter only			1		*	*	μF
Voltage Balance, V+, V-			0.04			*	*	%
Sensitivity to ΔV <sub>IN</sub>			1.15			*	*	V/V
Output Voltage Temp. Coefficient			10			*	*	mV/°C
Output Sync Signal	Square Wave, 50% duty cycle		30			*	*	V, p-p
	PWS725A/PWS726A only					*	*	
<b>TEMPERATURE</b>								
Specification		-25		+85	*	*	*	°C
Operating		-25		+85	*	*	*	°C
Storage		-25		+125	*	*	*	°C

## MECHANICAL

NOTE: Leads in true position within .010" (.25mm) R at MMC at seating plane.

Pin numbers shown for reference only. Numbers are not marked on package.

DIM	INCHES		MILLIMETERS	
	MIN	MAX	MIN	MAX
A	1.580	1.620	40.13	41.15
B	.880	.900	22.35	22.86
C	.310	.370	7.87	9.40
D	.016	.020	0.41	0.51
F	.040 TYP 1.02 TYP			
G	.100 BASIC 2.54 BASIC			
H	.044	.056	1.12	1.42
J	.009	.012	0.23	0.30
K	.150	.185	3.81	4.70
L	.900	.920	22.86	23.37
N	.040	.060	1.02	1.52

## PIN CONFIGURATION

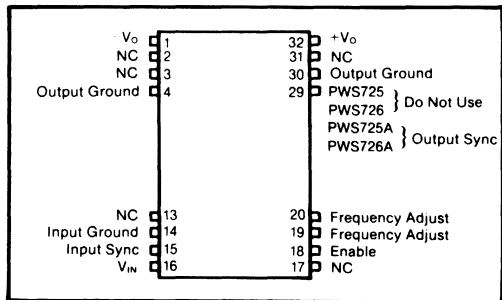

# TYPICAL PERFORMANCE CURVES

$T_A = -25^\circ\text{C}$ ,  $V_{CC} = \pm 15\text{VDC}$  unless otherwise noted

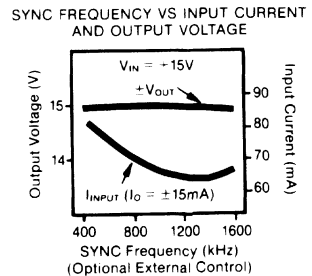
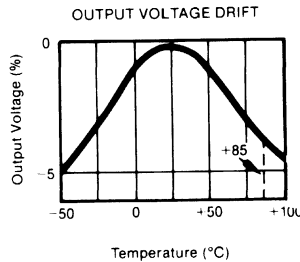
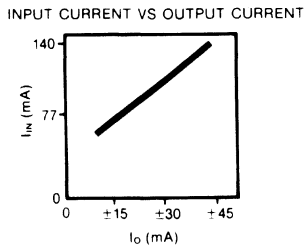
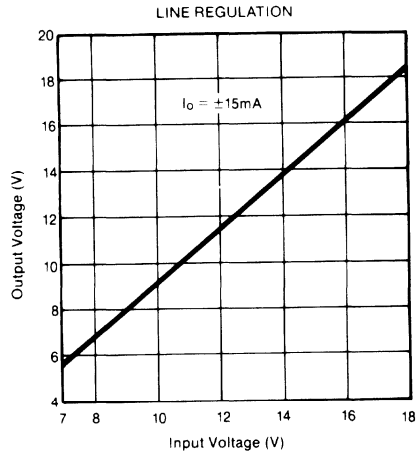
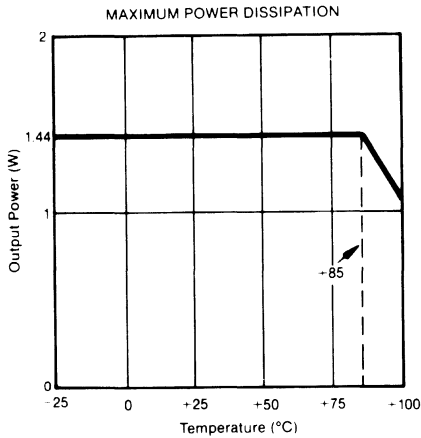
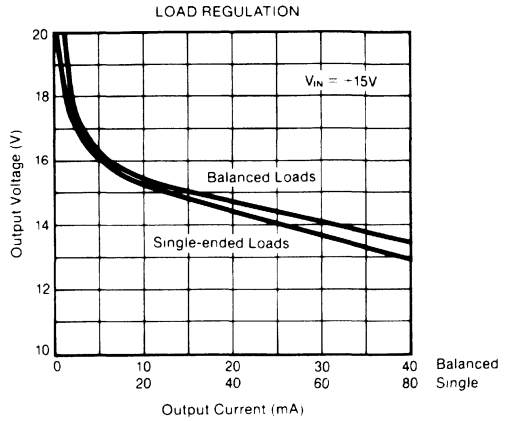
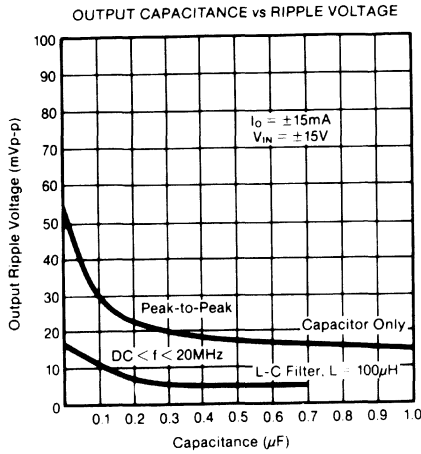

## THEORY OF OPERATION

The PWS725 and the PWS726 DC-to-DC converters consist of a free-running oscillator, control and switch driver circuitry, MOSFET switches, a transformer, a bridge rectifier, and filter capacitors together in a 32-pin DIP (0.900 inches nominal) package. The control circuitry consists of current limiting, soft start, frequency adjust, enable, and synchronization features. See Figure 1.

In instances where several converters are used in a system, beat frequencies developed between the converters are a potential source of low frequency noise in the supply and ground paths. This noise may couple into signal paths. See Figures 2 and 3 for connection of INPUT SYNC pin. Converters can be synchronized and these beat frequencies avoided. The unit with the highest natural

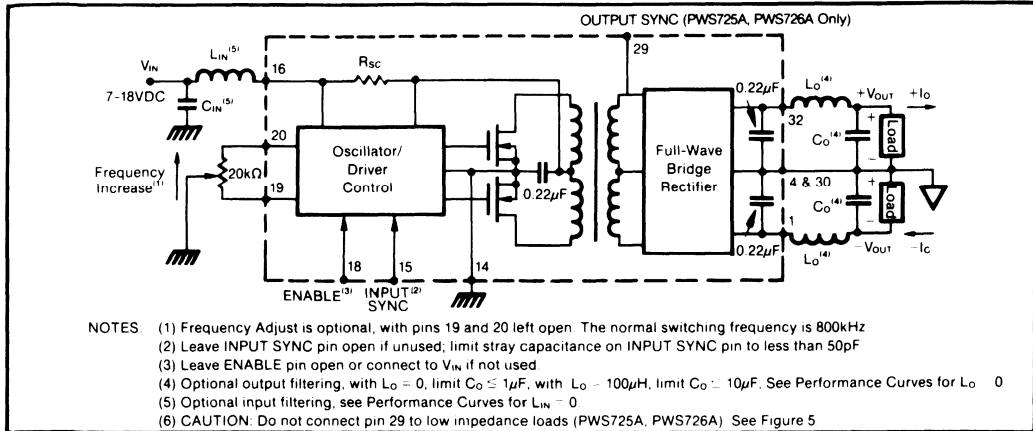

FIGURE 1. PWS725/726 Functional Diagram.

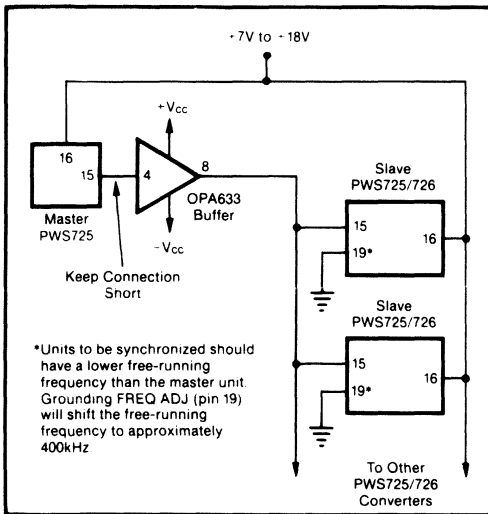

FIGURE 2. Synchronization of Multiple PWS725s or PWS726s from a Master Converter.

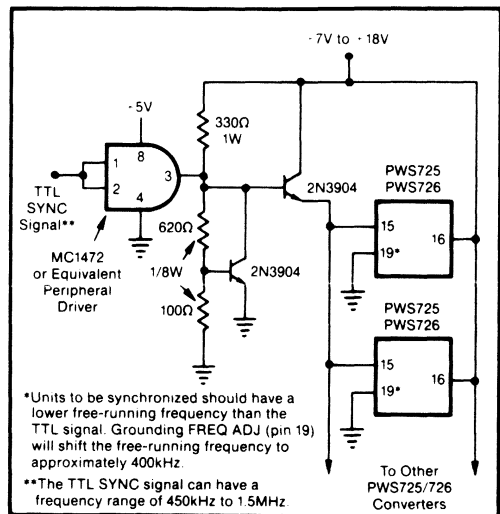

FIGURE 3. Synchronization of Multiple PWS725s or PWS726s from an External TTL Signal.

frequency will determine the synchronized running frequency. To avoid excess stray capacitance, the INPUT SYNC pin should not be loaded with more than 50pF. If unused, the INPUT SYNC must be left open.

Soft start circuitry protects the MOSFET switches during start up. This is accomplished by holding the gate-to-source voltage of both MOSFET switches low until the free-running oscillator is fully operational. In addition to the soft start circuitry, input current sensing also protects the MOSFET switches. This current limiting keeps the FET switches operating in their safe operating area under fault conditions or excessive loads. When either of these conditions occur, the peak input current exceeds a safe limit. The result is an approximate 5% duty cycle, 300μs drive period to the MOSFET switches. This protects the internal MOSFET switches as well as the external load from any thermal damage. When the fault

or excessive load is removed, the converter resumes normal operation. A delay period of approximately 50μs incorporated in the current sensing circuitry allows the output filter capacitors to fully charge after a fault is removed. This delay period corresponds to a filter capacitance of no more than 1μF at either of the output pins. This provides full protection of the MOSFET switches and also sufficiently filters the output ripple voltage (see specification table). The current sensing circuitry is designed to provide thermal protection for the MOSFET switches over the operating temperature range as well. The low thermal resistance of the package ( $\theta_{JC} = 10^\circ C/W$ ) ensures safe operation under rated conditions. When these rated conditions are exceeded, the unit will go into its shutdown mode.

An optional potentiometer can be connected between the two FREQUENCY ADJUST pins to trim the oscilla-

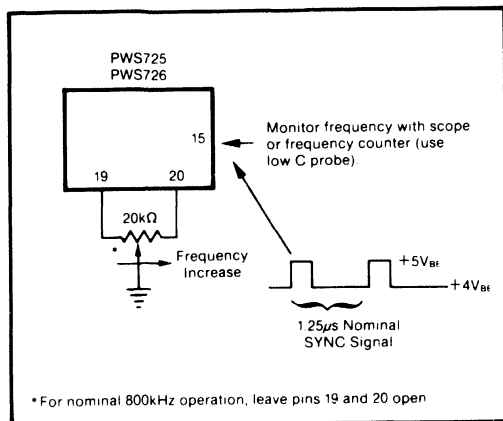

FIGURE 4. Frequency Adjustment Procedure.

tor operating frequency  $\pm 10\%$  (see Figure 4). Care should be taken when trimming the frequency near the low frequency range. If the frequency is trimmed too low, the peak inductive currents in the primary will trip the input current sensing circuitry to protect the MOSFET switches from these peak inductive currents.

The ENABLE pin allows external control of output power. When this pin is pulled low, output power is disabled. Logic thresholds are TTL compatible. When not used, the Enable input may be left open or tied to  $V_{IN}$  (pin 16).

**OUTPUT CURRENT RATING**

The total current which can be drawn from the PWS725 or PWS726 is a function of total power being drawn from both outputs (see Functional Diagram). If one output is not used, then maximum current can be drawn from the other output. If both outputs are loaded, the total current must be limited such that:

$$|I_1 +| + |I_1 -| \leq 80\text{mA}$$

It should be noted that many analog circuit functions do not simultaneously draw full rated current from both the

positive and negative supplies. For example, an operational amplifier may draw 13mA from the positive supply under full load while drawing only 3mA from the negative supply. Under these conditions, the PWS725/726 could supply power for up to five devices ( $80\text{mA} \div 16\text{mA} \approx 5$ ). Thus, the PWS725/726 can power more circuits than is at first apparent.

**ISOLATION VOLTAGE RATINGS**

Because a long-term test is impractical in a manufacturing situation, the generally accepted practice is to perform a production test at a higher voltage for some shorter period of time. The relationship between actual test conditions and the continuous derated maximum specification is an important one. Burr-Brown has chosen a deliberately conservative one:  $VDC_{TEST} = (2 \times VAC_{rms \text{ CONTINUOUS RATING}}) + 1000\text{V}$  for ten seconds. This choice is appropriate for conditions where system transient voltages are not well defined.\* Where the real voltages are well-defined or where the isolation voltage is not continuous, the user may choose a less conservative derating to establish a specification from the test voltage.

**OUTPUT SYNC SIGNAL**

To allow synchronization of an ISO120 or ISO121 isolation amplifier, the PWS725A and PWS726A have an OUTPUT SYNC signal at pin 29. It should be connected as shown in Figure 5 to keep capacitive loading of pin 29 to a minimum.

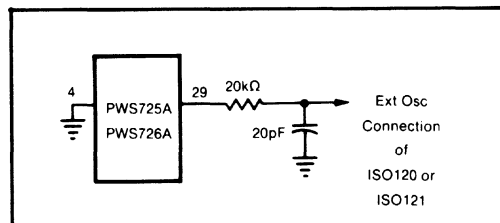

FIGURE 5. Synchronization with ISO120 or ISO121 Isolation Amplifier.

\*Reference National Electrical Manufacturers Association (NEMA) Standards Parts ICS 1-109 and ICS 1-111.





# PWS740

## Distributed Multichannel Isolated DC-TO-DC CONVERTER

### FEATURES

- ISOLATED  $\pm 7$  TO  $\pm 20$ VDC OUTPUTS
- BARRIER 100% TESTED AT 1500VAC, 60Hz
- LOWEST POSSIBLE COST PER CHANNEL
- MINIMUM PC BOARD SPACE
- 80% EFFICIENCY (8 CHANNELS, RATED LOADS)

### APPLICATIONS

- INDUSTRIAL MEASUREMENT AND CONTROL
- DATA ACQUISITION SYSTEMS
- TEST EQUIPMENT

### DESCRIPTION

The PWS740 is a multichannel, isolated DC-to-DC converter with a 1500VAC continuous isolation rating. The outputs track the input voltage to the converter over the range of 7 to 20VDC. The converter's modular design, comprising three components, minimizes the cost of isolated multichannel power for the user.

The PWS740-1 is a high-frequency (400kHz nominal) oscillator/driver, handling up to eight channels. This part is a hybrid containing an oscillator and two power FETs. It is supplied in a TO-3 case to

provide the power dissipation necessary at full load. Transformer impedance limits the maximum input current to about 700mA at 15V input, well within the unit's thermal limits. A TTL-compatible ENABLE pin provides output shut-down if desired. A SYNC pin allows synchronization of several PWS740-1s.

The PWS740-2 is trifilar-wound isolation transformer using a ferrite core and is encapsulated in a plastic package, allowing a higher isolation voltage rating. The PWS740-3 is a high-speed rectifier bridge in a plastic 8-pin mini-DIP package. One PWS740-2 and one PWS740-3 are used per isolated channel.

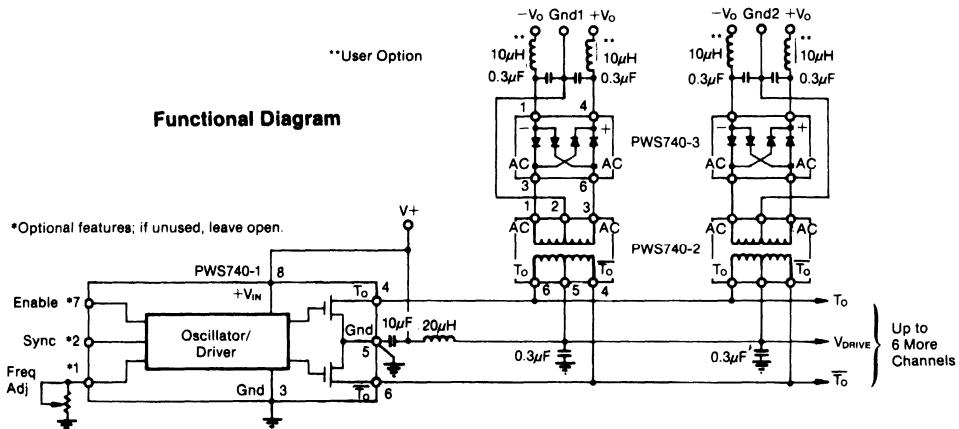

International Airport Industrial Park • P.O. Box 11400 • Tucson, Arizona 85734 • Tel.: (602) 746-1111 • Twx: 910-952-1111 • Cable: BBRRCORP • Telex: 66-6491

PDS-758B

# SPECIFICATIONS

## ELECTRICAL

NOTE:  $V_{IN} = 15V$ , output load on each of 8 channels =  $\pm 15mA$ ,  $T_A = +25^\circ C$  unless specified otherwise.

PARAMETER	CONDITION	MIN	TYP	MAX	UNITS
<b>PWS740 SYSTEM</b>					
<b>ISOLATION</b>					
Rated Voltage	Continuous, AC, 50/60Hz Continuous, DC			1500 2121	VACrms VDC
Test Voltage	10s, minimum	4000	$10^{12} \parallel 3$		VACrms
Impedance	Measured from pin 2 to pin 5 of the PWS740-2		0.5		$\Omega \parallel pF$
Leakage Current	240VACrms, 60Hz per channel			1.5	$\mu A$
<b>INPUT</b>					
Rated Voltage			15		VDC
Voltage Range		7		20	VDC
Current	$\pm 30mA$ output load on 8 channels, $V_{IN} = 15V$ Rated output load on 8 channels, $V_{IN} = 15V$		520 300		mA mA
Current Ripple	Full output load on 8 channels, $V_{IN} = 15V$ with $\pi$ filter on input		1		mA
<b>OUTPUT</b>					
Rated Voltage	$\pm 15mA$ output load on 8 channels	14.0	15.0	16.0	VDC
Voltage at Min Load	$\pm 1mA$ /channel		30		VDC
Voltage Range	$\pm 15mA$ output load on each channel	$\pm 7$		$\pm 20$	VDC
$V_{OUT}$ vs Temp	$\pm 15mA$ output load on each channel		$\pm 0.05$		V/ $^\circ C$
Load Regulation	$\pm 3mA <$ output load $< \pm 30mA$		0.25		V/mA
Tracking Regulation	$V_{OUT}/V_{IN}$		1.2		V/V
Ripple Voltage	See Typical Performance Curves				
Noise Voltage	See Theory of Operation				
Current $ +I_{OUT}  +  -I_{OUT} $	Each channel			60	mA
<b>TEMPERATURE</b>					
Specification		-25		+85	$^\circ C$
Operation		-25		+85	$^\circ C$
<b>PWS740-1 OSCILLATOR/DRIVER</b>					
Frequency	$V_{IN} = 15V$	350	400	470	kHz
Supply		7.0	15.0	20.0	V
Enable	Drivers on	2.0		$V_s$	V
	Drivers off	0		0.8	V
<b>PWS740-2 ISOLATION TRANSFORMER</b>					
Isolation Test Voltage	10s, minimum	4000			VACrms
Rated Isolation Voltage	60s, minimum	1500			VACrms
Isolation Impedance	Continuous		$10^{12} \parallel 3$	1500	VACrms
Isolation Leakage	240VAC		0.5	1.5	$\mu A$
Primary Inductance	400kHz, Pin 1 to Pin 5		300		$\mu H$
Winding Ratio	Primary/Secondary		68/76		
<b>PWS740-3 DIODE BRIDGE</b>					
Reverse Recovery	$I_F = I_R = 50mA$		40		ns
Reverse Breakdown	$I_R = 100\mu A$	55			V
Reverse Current	$V_R = 40V$			1.5	$\mu A$
Forward Voltage	$I_F = 100mA$			1.6	V

### PIN CONFIGURATIONS

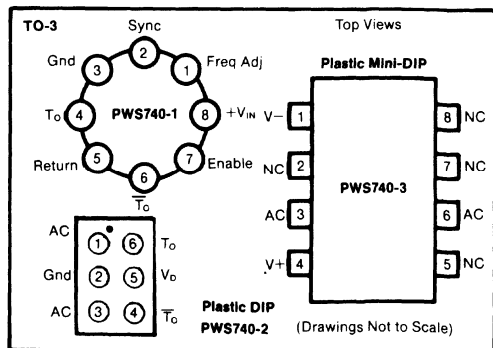

**MECHANICAL**

**TO-3**

Seating Plane

Bottom View

NOTE: Leads in true position within 0.010" (0.25mm) R at MMC at seating plane.

Pin numbers shown for reference only. Numbers may not be marked on package.

DIM	INCHES		MILLIMETERS	
	MIN	MAX	MIN	MAX
A	1.510	1.550	38.35	39.37
B	.745	.770	18.92	19.56
C	.240	.290	6.10	7.37
E	.038	.042	0.97	1.07
D	.080	.105	2.03	2.67
F	40° BASIC		40° BASIC	
G	500 BASIC		12.7 BASIC	
H	1.186 BASIC		30.12 BASIC	
J	.593 BASIC		15.06 BASIC	
K	.400	.500	10.16	12.70
Q	.151	.161	3.84	4.09
R	.980	1.020	24.89	25.91

**Plastic DIP**

Pin 1 Identifier

Top View

NOTE: Leads in true position within 0.010" (0.25mm) R at MMC at seating plane.

DIM	INCHES		MILLIMETERS	
	MIN	MAX	MIN	MAX
A	0.54	0.64	13.72	16.26
B <sub>1</sub>	0.39	0.49	9.91	12.45
B <sub>2</sub>	0.54	0.64	13.72	16.26
C <sub>1</sub>	0.39	.052	9.91	13.21
C <sub>2</sub>	0.29	.044	8.64	11.18
G	.200 BASIC		5.08 BASIC	
K	0.11	0.21	2.79	5.33
L	.400 BASIC		10.16 BASIC	

**Plastic Mini-DIP**

Top View

Pin 1

Seating Plane

NOTE: Leads in true position within 0.010" (0.25mm) R at MMC at seating plane.

DIM	INCHES		MILLIMETERS	
	MIN	MAX	MIN	MAX
A	.355	.400	9.03	10.16
A <sub>1</sub>	.340	.385	8.65	9.80
B	.230	.290	5.85	7.38
B <sub>1</sub>	.200	.250	5.09	6.36
C	.120	.200	3.05	5.09
D	.015	.023	0.38	0.59
F	.030	.070	0.76	1.78
G	.100 BASIC		2.54 BASIC	
H	.025	.050	0.64	1.27
J	.008	.015	0.20	0.38
K	.070	.150	1.78	3.82
L	.300 BASIC		7.63 BASIC	
M	0°	15°	0°	15°
N	.010	.030	0.25	0.76
P	.025	.050	0.64	1.27

**TYPICAL PERFORMANCE CURVES**

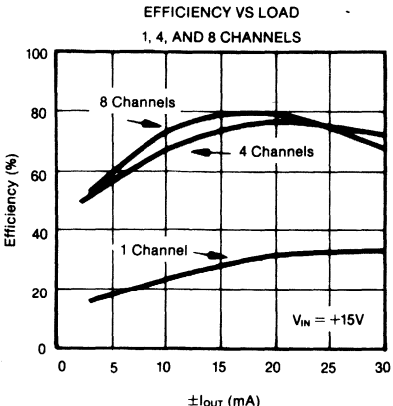
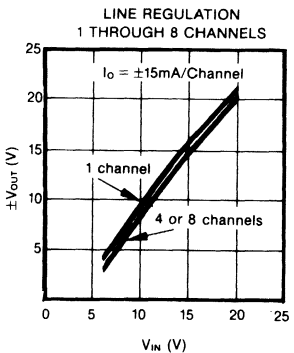
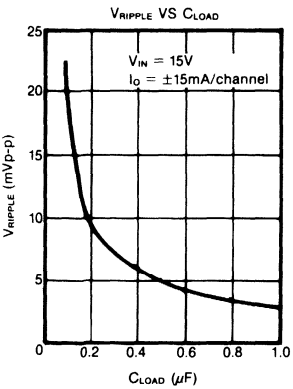

## TYPICAL PERFORMANCE CURVES (CONT)

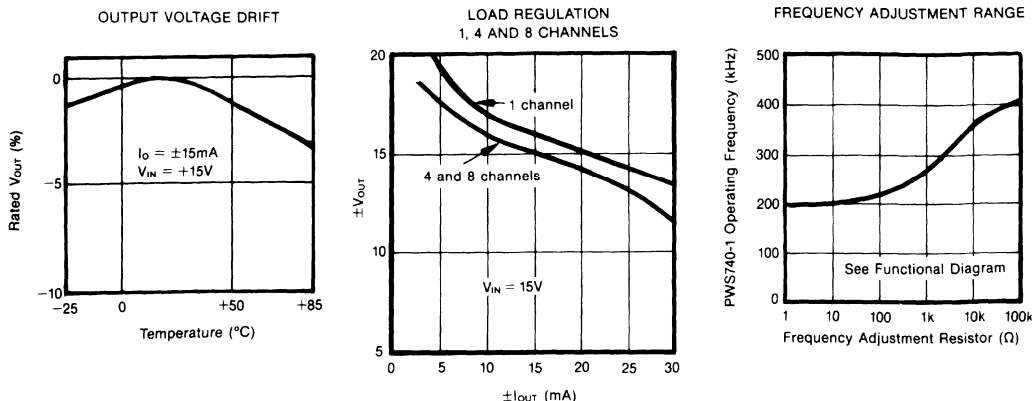

## PIN DESCRIPTIONS OF PWS740-1 DRIVER

### + $V_{IN}$ , RETURN, AND GND

These are the power supply pins. The ground connection, RETURN, for the N-channel MOSFET sources is brought out separately from the ground connection for the oscillator/driver chip. The waveform of the FETs' ground return current (and also the current in the  $V_{DRIVE}$  line) is an 800kHz sawtooth. A capacitor between + $V_{IN}$  and the FET ground provides a bypass for the AC portion of this current.

The power should never be instantaneously interrupted to the PWS740 system (i.e., a break in the line from  $V+$ , either accidental or by means of a series switch). Normal power-down of the  $V+$  supply is not considered instantaneous. Should a rapid break in input power occur, however, the transformers' voltage will rapidly increase to maintain current flow. Such a voltage spike may damage the PWS740-1. The bypass capacitors at the + $V_{IN}$  pin of the PWS740-1 and the  $V_{DRIVE}$  pins of the transformers provide a path for the primary current if power is interrupted; however, total protection requires some type of bidirectional 1A voltage clamping at the + $V_{IN}$  pin. A low cost SA20A TransZorb<sup>®</sup> from General Semiconductor<sup>(1)</sup> or equivalent, which will clamp the  $V_{IN}$  pin between  $-0.6\text{V}$  and  $+23\text{V}$ , is recommended.

### $T_0$ AND $\bar{T}_0$

These pins are the drains of the N-channel MOSFET switches which drive all the transformer primaries in parallel. The signals on these pins are 400kHz complementary square waves with twice the amplitude of the voltage at + $V_{IN}$ . It is these lines that allow the power to be distributed to the individual high voltage isolation transformers. Without proper printed circuit board layout

techniques, these lines could generate interference to analog circuits. See the next section on PCB layout.

### ENABLE

A high TTL logic level on this pin activates the MOSFET driver circuitry. A low TTL level applied to the ENABLE pin shuts down all drive to the transformers and the output voltages go to zero (only the oscillator is unaffected). For continuous operation, the ENABLE pin can be left open or tied to a voltage between +2V and  $V+$ .

### SYNCHRONIZATION

The SYNC pin is used to synchronize up to eight PWS740-1 oscillators. Synchronization is useful to prevent beat frequencies in the supply voltages. The SYNC pins of two or more PWS740-1s are tied together to force all units to the same frequency of oscillation. The resultant frequency is slightly higher than that of the highest unsynchronized unit. If this feature is not required, leave the SYNC pin open. The SYNC pin is sensitive to capacitance loading. 150pF or less is recommended. Also external parasitic capacitive feedback between either  $T_0$  and the SYNC pin can cause unstable operation (commonly seen as jitter in the  $T_0$  outputs). Keep SYNC connections and  $T_0$  lines as physically isolated as possible. Avoid shorting the SYNC pin directly to ground or supply potentials; otherwise, damage may result.

Figure 1 shows a method for synchronizing a greater number of PWS740-1 drivers. One unit is chosen as the master. Its synchronization signal, buffered by a high-speed unity gain amplifier can synchronize up to 20 slave units. Pin 1 of each slave unit must be grounded to assure synchronization. Minimize capacitive coupling between the buffered sync line and the outputs of the drivers, especially at the end of long lines. Capacitance to ground is not critical, but total stray capacitance between the sync line and switching outputs should be kept below 50pF. Where extreme line lengths are needed,

(1) General Semiconductor Industries Inc., 2001 W. 10th Place, Tempe AZ 85281. 602-968-3101.

TransZorb<sup>®</sup> General Semiconductor Industries Inc.

such as between printed circuit boards, additional OPA633 buffers may be added to keep drive impedance at an acceptably low value. Because of temperature-influenced shifts in the switching levels, best operation of this circuit will occur when differences in ambient temperatures between the PWS740-I drivers are minimized, typically within a 35°C range.

If larger temperature gradients are likely to occur, the user may wish to consider the synchronization method shown in Figure 2. This circuit is driven from an external TTL-compatible source such as a system clock or a simple free-running oscillator constructed of TTL gates. The output stage provides temperature compensation over the rated temperature range of the PWS740. The signal source frequency should be about 800kHz for rated performance, but may range from 500kHz to 2MHz with slightly reduced performance. Precautions with regard to circuit coupling and layout are the same as for the circuit of Figure 1. Repeaters using the OPA633 may be used for long line lengths. Symmetry and good high-frequency layout practice are important in successful application of both of these synchronization techniques.

### FREQUENCY ADJUSTMENT

The **FREQ ADJ** pin may be connected to an external potentiometer to lower an unsynchronized PWS740-I oscillator frequency. This may be useful if the frequency of the PWS740-I is too close to some other signal's frequency in the system and beat interference is possible. See Typical Performance Curves. Use of this pin is not usually required; if not used, leave open for rated performance.

## THEORY OF OPERATION

### EXTERNAL FILTER COMPONENTS

Filter components are necessary to reduce the input ripple current and the output voltage noise. Without any input filtering, the sawtooth currents in the FET switches would flow in the  $V+$  supply line. Since this AC current can be as great as 1A peak, voltage interference with other components using this supply line would likely occur. The input ripple current can be reduced to approximately 1mA peak with the addition of two components—a bypass capacitor between the  $+V_{IN}$  pin and ground, and a series inductor in the  $V_{DRIVE}$  line. A 10 $\mu$ F tantalum capacitor is adequate for bypass. A parallel 0.33 $\mu$ F ceramic capacitor will extend the bandwidth of the tantalum. Additional bypass capacitors at each primary center-tap of the transformers are recommended. In general, the higher the capacitance, the lower the ripple, but the parasitic series inductance of the bypass capacitors will eventually be the limiting factor. The inductor value recommended is approximately 20 $\mu$ H. Greater reduction in ripple current is achieved with values up to 100 $\mu$ H; then physical size may become a concern. The inductor should be rated for at least 2A

and its DC resistance should be less than 0.1 $\Omega$ . An example of a low cost inductor is part number 51591 from Pulse Engineering<sup>(2)</sup>.

Output voltage filtering is achieved with a 0.33 $\mu$ F capacitor connecting each  $V_{OUT}$  pin of the diode bridge to ground. Short leads and close placement of the capacitors to the unit provide optimum high frequency bypassing. The 800kHz output ripple should be below 5mVp-p. Higher frequency noise bursts are also present at the outputs. They coincide with the switch times and are approximately 20mV in amplitude. Inductance of 10 $\mu$ H or less in series with the output loads will significantly reduce the noise as seen by the loads.

### PC BOARD LAYOUT CONSIDERATIONS

Multilayer printed circuit boards are recommended for PWS740 systems. Two-layer boards are certainly possible with satisfactory operation; however, three layers provide greater density and better control of interference from the FET switch signals. Should four-layer boards be required for other circuitry, the use of separate layers for power and ground planes, a layer for switching signals, and a layer for analog signals would allow the most straightforward layout for the PWS740 system. The following discussion pertains to a three- or four-layer board layout.

Critical consideration should go to minimizing electromagnetic radiation from the switching signal's lines,  $T_O$  and  $\bar{T}_O$ . You can identify the path of the switching current by starting at the  $+V_{IN}$  pin. The dynamic component of the current is supplied primarily from the bypass capacitor. The high frequency current flows through the inductor and down the  $V_{DRIVE}$  line, through one side of the transformer windings, returning in the  $T_O$

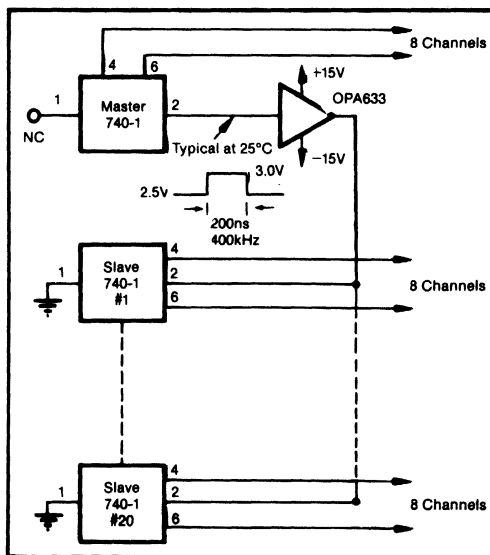

FIGURE 1. Master/Slave Synchronization of Multiple PWS740 Drivers.

(2) Pulse Engineering, PO Box 12235, San Diego CA 92112, 619-268-2400.

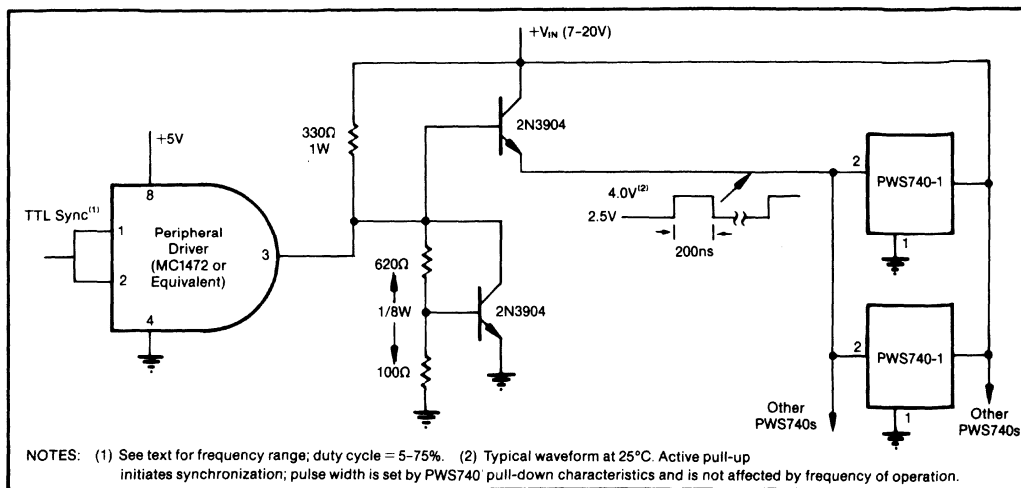

FIGURE 2. External Synchronization of Multiple PWS740 Drivers with TTL-Level Signals.

with the “on” FET switch, and then back up through the bypass capacitor. This current path defines a loop antenna which transmits magnetic energy. The magnetic field lines reinforce at the center of the loop, while the field lines from opposite points of the loop oppose each other outside the loop. Cancellation of magnetic radiation occurs when the loop is collapsed to two tightly spaced parallel line segments, each carrying the same current in opposite directions. For this reason, the printed circuit traces for both  $T_O$  connections should lay directly over a power plane forming the  $V_{DRIVE}$  connection. This plane need not extend much wider than  $T_O$  and  $T_O$ . All of the current in the plane will flow directly under the  $T_O$  traces because this is the path of least inductance (and least radiation).

Another potential problem with the  $T_O$  lines is electric field radiation. Fortunately, the  $V_{DRIVE}$  plane is effective at terminating most of the field lines because of its proximity to these lines. Additional shielding can be obtained by running ground trace(s) along the  $T_O$  lines, which also facilitate minimum loop area connections for the transformer's center tap bypass capacitors.

The connections between the secondary (output side) of the transformer and the diode bridges should be kept as short as possible. Unnecessary stray capacitance on these lines could cause tuned circuit peaking to occur, resulting in a slight increase of output voltage.

The PWS740 is intended for use with the ISO102 isolation buffer (see Figure 3). Place the PWS740-2 transformer on the  $V_{OUT}$  side of the buffer rather than on the  $C_1$  (bandwidth control) side to prevent possible pickup of switch signal by the ISO102.

The best ground connection ties the ISO102 output analog common pin to the PWS740-1 ground pin with a ground plane. This is where a four-layer board design becomes convenient. The digital ground of the ISO102 can be connected to the ground plane or closer to the +V

supply. If possible, you should include the analog components that the ISO102 drives on the same board. For example, if several ISO102s are multiplexed to an analog/digital converter, then having all components sharing the same ground plane will significantly simplify ground errors. Avoid connecting digital ground and the PWS740 ground together locally, leaving the ISO102 analog ground to be connected off of the board; the differential voltage between analog and digital ground may become too great.

### OUTPUT CURRENT RATINGS

The PWS740-1 driver contains “soft-start” driver circuitry to protect the driver FETs and eliminate high inrush currents during turn-on. Because the PWS740 can have between one and eight channels connected, it was not possible to provide a suitable internal current limit within the driver. Instead, impedance-limiting protects the driver and transformer from overload. This means that the internal impedance of each PWS740-2 transformer is high enough that, when short-circuited at its output, it limits the current drawn from the driver to a safe value. In addition, the wire size and mass of the transformer are large enough that the transformer does not receive damage under continuous short-circuit conditions.

The PWS740-1 is capable of driving up to eight individual channels to their full current rating. The total current which can be drawn from each isolation channel is a function of total power being drawn from both DC  $V+$  and  $V-$  outputs. For example, if one output is not used, then maximum current can be drawn from the other output. In all cases, the maximum total current that can be drawn from any individual channel is:

$$|I_{L+}| + |I_{L-}| \leq 60\text{mA}$$

It should be noted that many analog circuit functions do not simultaneously draw full rated current from both the

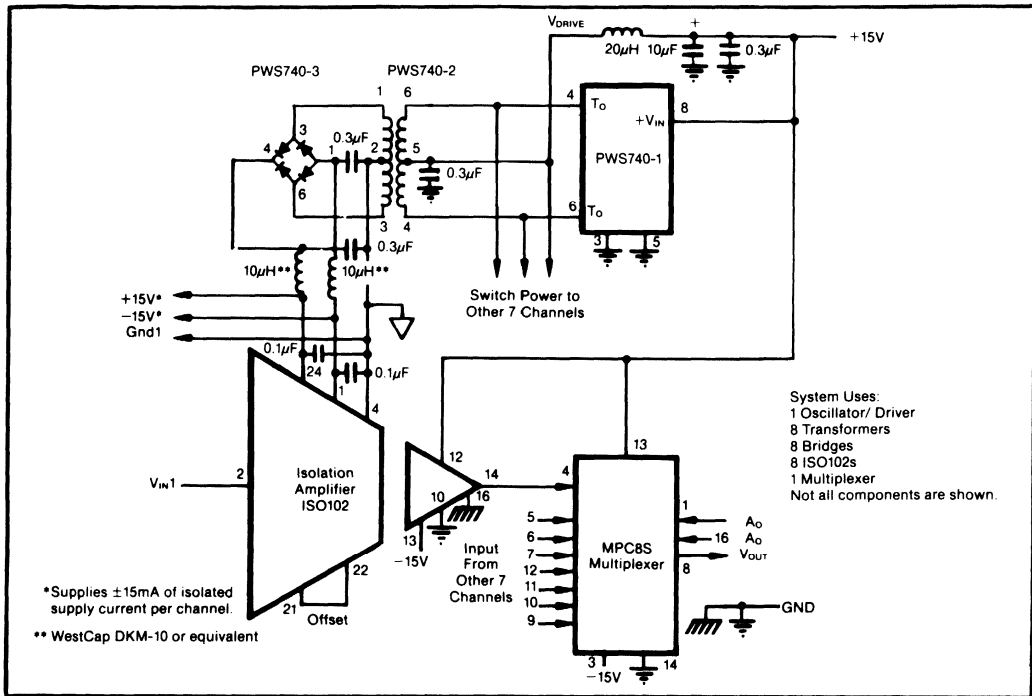

FIGURE 3. Low Cost Eight-Channel Isolation Amplifier Block with Channel-to-Channel Isolation.

positive and negative supplies. Thus, the PWS740 can power more circuits per channel than is first apparent. For example, an operational amplifier does not draw maximum current from both supplies simultaneously. If a circuit draws 10mA from the positive supply and 3mA from the negative supply, the PWS740 could power  $(60 \div 13)$  about four devices per channel.

### ISOLATION VOLTAGE RATINGS

Because a long-term test is impractical in a manufacturing situation, the generally accepted practice is to

perform a production test at a higher voltage for some shorter period of time. The relationship between actual test conditions and the continuous derated maximum specification is an important one. Burr-Brown has chosen a deliberately conservative one:  $V_{\text{TEST}} = (2 \times V_{\text{CONTINUOUS RATING}}) + 1000\text{V}$ . This choice is appropriate for conditions where system transient voltages are not well defined.<sup>(3)</sup> Where the real voltages are well-defined or where the isolation voltage is not continuous, the user may choose a less conservative derating to establish a specification from the test voltage.

(3) Reference National Electrical Manufacturers Association (NEMA) Standards part ICS I-109 and ICSI-III.

## NOTES





# BURR-BROWN INTERNATIONAL SALES OFFICES & SALES REPRESENTATIVES

## AUSTRALIA

Kenelec (AUST) Pty. Ltd.  
48 Henderson Rd. Clayton  
Victoria 3168  
Tel: 61-3-560-1011  
FAX: 61-3-560-1804  
TLX: 790 35703 KENLEC

## AUSTRIA

Burr-Brown Research, GesmbH  
Senefeldergasse 11  
A-1100 Vienna  
Tel: 43-222-626371  
FAX: 43-222-6272295  
TLX: 847 134777 BBW A

## BELGIUM

Burr-Brown International N.V.  
Copenlaan 118  
B-1180 Brussels  
Tel: 32-2-3474430  
FAX: 32-2-3435989  
TLX: 846 62805

## CANADA

Allan Crawford Associates  
5835 Coopers Ave.  
Mississauga, Ont. L4V 1Y2  
Tel: 416-890-2010  
FAX: 416-890-1959  
TLX: 06 961234

## DENMARK

MER-EL A/S  
Ved Kloedebo 18  
KD-2970 Hoersholm  
Tel: 45-2-57-1000  
FAX: 45-2-57-2299  
TLX: 855 37360 MEREL DK

## FINLAND

Perel Oy  
Kekkonen 6  
SF-06830 Hyyinkaa 3  
Tel: 358-14-21600  
FAX: 358-14-21609  
TLX: 857 15117 PEREL SF

## FRANCE

Burr-Brown International S.A.  
18 Avenue Dutarre  
F-78150 La Chesnay  
Tel: 33-1-9543558  
FAX: 33-1-39512484  
TLX: 842 896372 F BURBRWN

## GREECE

Macedonian Electronics, S.A.  
PO Box 10240  
541 10 Thessaloniki - Hellas  
Tel: 30-31-306-800  
TLX: 863 412584 MAEL GR

## HONG KONG

Schmidt & Co. (HK) Ltd.  
18th Floor, Great Eagle Centre  
23 Harbour Road  
Wanchai  
Tel: 862-5-8330222  
FAX: 862-5-8918754  
TLX: 780 74766 SCHMC HK

## HUNGARY

Siex Elektronikelemente, GmbH  
Marianbader Str. 42  
Postfach 1365  
D-8502 Zirndorf  
Fed. Republic of Germany  
Tel: 49-911-60-7014  
FAX: 49-911-60-8862  
TLX: 841 623486 SIEX D

## INDIA

Oriole Services & Consultants, Pvt. Ltd.  
PO Box 21120  
4, Kuria Industrial Estate  
Ghatkopar, Bombay 400 086  
Tel: 91-22-512-2973  
TLX: 953 1172102 OSC IN

## INDONESIA

Microtronics Associates Pte. Ltd.  
8 Lorong Bakar Batu  
03-01, Kolam Ayer Industrial Park  
Singapore-1334  
Tel: 65-748-1835  
FAX: 65-743-3065  
TLX: 786 34929 MICRO

## ISRAEL

Racom Electronics Co. Ltd.  
PO Box 21120  
Tel-Aviv 61210  
Tel: 972-3-491922  
FAX: 972-3-491576  
TLX: 922 33808 RACEL IL

## ITALY

Burr-Brown International S.R.L.  
Via Zanle 14  
20138 Milano  
Tel: 39-2-5065228  
FAX: 39-2-504709  
TLX: 843 316246 B BROWN I

## JAPAN

Burr-Brown Japan Ltd  
2F, Natural House Bldg  
14-15-6 Chome, Akasaka  
Minato-ku, Tokyo 107  
Tel: 81-3-5868141  
FAX: 81-3-5822940

## MALAYSIA

Microtronics Associates Pte. Ltd.  
8 Lorong Bakar Batu  
03-01, Kolam Ayer Industrial Park  
Singapore-1334  
Tel: 65-748-1835  
FAX: 65-743-3065  
TLX: 786 34929 MICRO

## NETHERLANDS

Burr-Brown International B. V.  
PO Box 7735  
1117 ZL Schiphol  
Tel: 31-20-470590  
FAX: 31-20-470357  
TLX: 844 13024 B BWN NL

## NEW ZEALAND

Northrop Instruments & Systems Ltd.  
Private Bag, 12 Kent Street  
New Market, Auckland  
Tel: 64-9-587-037  
FAX: 64-9-587-276  
TLX: 791 21570 THERMAL

## NORWAY

Hefro Elektronik A/S  
Haavard Martinsensvei 19  
Postboks 6 Haugenstua  
N-0915 Oslo-9  
Tel: 47-2-107300  
FAX: 47-2-106546  
TLX: 856 76205 HEFRO N

## PORTUGAL

Cristalonica  
Componentes de Radio e Televisao, LDA  
Rua Bernardino Ribeiro, 25 R/C Dto. e Esq.  
1100 Lisboa  
Tel: 351-1-534631 or 540314  
FAX: 351-1-561755  
TLX: 832 64119 CRISTA P

## SINGAPORE

Microtronics Associates Pte. Ltd.  
8 Lorong Bakar Batu  
03-01, Kolam Ayer Industrial Park  
Singapore-1334  
Tel: 65-748-1835  
FAX: 65-743-3065  
TLX: 786 34929 MICRO

## SOUTH AFRICA

Advanced Semiconductor Devices (Pty) Ltd.  
PO Box 2944  
Johannesburg-2000  
Tel: 27-802-5820  
FAX: 27-802-4593  
TLX: 960 428201 SA

## SOUTH KOREA

Oyang Corporation  
CPO Box 3285  
Sun Jin Bldg. 164, Angukdong  
Chongrogu, Seoul-110  
Tel: 82-2-732-8031  
FAX: 82-2-732-8049  
TLX: 787 22679 OYCORP K

## SPAIN

Unitronics, S.A.  
Torre de Madrid  
Planta 12, Oficina 9  
Madrid-28008  
Tel: 34-1-242-5204  
FAX: 34-1-248-4228  
TLX: 831 46786 UTRON E

## SWEDEN

Burr-Brown International A.B.  
19461 Upplands Vasty  
Kanalvagen 5  
Tel: 46-76093010  
FAX: 46-76094362  
TLX: 854 14489 BBIAB S

## SWITZERLAND

Burr-Brown A.G.  
Weingartenstrasse 9  
CH8803 Rueschlikon Zurich  
Tel: 41-1-7240928  
FAX: 41-1-7240410  
TLX: 845 59880 BUBR CH

## TAIWAN

Alpha Precision Instrumentation Corporation  
11th Floor, 71, Sung Chiang Road  
Taipei, R.O.C.  
Tel: 886-2-508-3066  
FAX: 886-2-507-7185  
TLX: 785 25138 APIC

## THAILAND

Microtronics Associates Pte. Ltd.  
8 Lorong Bakar Batu  
03-01, Kolam Ayer Industrial Park  
Singapore-1334  
Tel: 65-748-1835  
FAX: 65-743-3065  
TLX: 786 34929 MICRO

## TURKEY

Burc Electronics & Machinery Corp.  
Bankalar, Okumusa cad. no:54  
Menese Han Kat:4 Karakoy, Istanbul  
Tel: 90-1-153-5465  
FAX: 90-1-153-5468  
TLX: 821 25883 BUEM TR

## UNITED KINGDOM

Burr-Brown International Ltd.  
1 Millfield House  
Woodstocks Meadow, Watford  
Hertfordshire WD1 8YX  
Tel: 44-92333637  
FAX: 44-92333979  
TLX: 851 922461 BB WFDD

## UNITED MEXICAN STATES

(Components only)  
Disapel, S.A. de C.V.  
Tochitl 388 Fracc. Ind.  
Sn. Antonio Arzapatozaco  
C.P. 02760 Mexico, D.F.  
Tel: 52-5-561-3211  
FAX: 52-2-561-1279  
TLX: 383 177390 DICOME

## WEST GERMANY

Burr-Brown International GmbH  
Weidacher Strasse 26  
D-7024 Filsterstadt 1  
Tel: 49-711-701025  
FAX: 49-711-706341  
TLX: 841 177111257

## YUGOSLAVIA

Elektrotrenja Ljubljana Do Junel  
Tozd Elzas  
61000 Ljubljana, Poljanska 25  
Tel: 38-61-329745  
TLX: 862 31767 YU ELZAS

# BURR-BROWN U.S.A. SALES OFFICES & SALES REPRESENTATIVES

## BURR-BROWN WORLDWIDE HEADQUARTERS

International Airport Ind Park  
**Mailing Address:**  
 PO Box 11400  
 Tucson, AZ 85734  
**Street Address:**  
 6730 S. Tucson Blvd.  
 Tucson, AZ 85706  
 Tel: (602) 746-1111  
 TWX: 910-952-1111  
 Cable: BBRCORP  
 Telex: 66-6491  
 FAX: (602) 889-1510

## ALABAMA

Rep. Inc.  
 PO Box 4889  
 11535 Gilleland Road  
 Huntsville, AL 35815-0889  
 Tel: (205) 881-9270  
 TWX: 810-726-2102  
 EZLINK 62608310  
 FAX: (205) 882-6692

## ALASKA

Burr-Brown Corporation  
 523 S. Washington Ave.  
 Kent, WA 98032  
 Tel: (206) 859-9220  
 FAX: (206) 859-9276

## ARIZONA

Burr-Brown Corporation  
 Suite 107B  
 2121 So. Mill Ave.  
 Tempe, AZ 85282  
 Tel: (602) 966-4601  
 FAX: (602) 966-5015

## ARKANSAS

Burr-Brown Corporation  
 11882 Greenville Ave.  
 Suite 128, LB#16  
 Dallas, TX 75243  
 Tel: (214) 783-4555  
 FAX: (214) 783-2717

## CALIFORNIA (Northern)

Burr-Brown Corporation  
 Suite 6  
 1975 Hamilton Avenue  
 San Jose, CA 95125  
 Tel: (408) 559-8600  
 FAX: (408) 559-0354

## CALIFORNIA (Southern)

Burr-Brown Corporation  
 Suite 112  
 28310 Roadside Drive  
 Agoura, CA 91301  
 Tel: (818) 991-8544 or  
 (805) 496-7581  
 FAX: (818) 991-7872

Burr-Brown Corporation  
 Suite 104  
 2001 E. Fourth Street  
 Santa Ana, CA 92705  
 Tel: (714) 835-0712  
 FAX: (714) 541-5621

## COLORADO

Burr-Brown Corporation  
 Suite 108  
 9025 Grant Street  
 Denver, CO 80229  
 Tel: (303) 452-3645  
 FAX: (303) 452-3652

## CONNECTICUT

Burr-Brown Corporation  
 Suite 402  
 984 North Broadway  
 Yonkers, NY 10701  
 Tel: (914) 964-5525  
 FAX: (914) 964-6652

## DELAWARE

QED Electronics Inc.  
 PO Box 487  
 805 North Bethlehem Pike  
 Spring House, PA 19477  
 Tel: (215) 643-9200  
 TWX: EZLINK 62931798  
 FAX: (215) 643-9213

## FLORIDA (Northern)

Burr-Brown Corporation  
 Suite 108  
 5151 Adamson Street  
 Orlando, FL 32804-1315  
 Tel: (407) 740-9200  
 FAX: (407) 740-7418

## FLORIDA (Southern)

Burr-Brown Corporation  
 Suite 200  
 2875 South Ocean Blvd.  
 Palm Beach, FL 33480  
 Tel: (407) 586-7162

## GEORGIA

Rep. Inc.  
 1944 Northlake Parkway #1  
 Tucker, GA 30084  
 Tel: (404) 938-4358  
 TWX: 810-766-0822  
 FAX: (404) 938-0194

## HAWAII

Burr-Brown Corporation  
 Suite 112  
 28310 Roadside Drive  
 Agoura, CA 91301  
 Tel: (818) 991-8544 or  
 (805) 496-7581  
 FAX: (818) 991-7872

## IDAHO

Burr-Brown Corporation  
 523 S. Washington Ave.  
 Kent, WA 98032  
 Tel: (206) 859-9220  
 FAX: (206) 859-9276

## ILLINOIS (Northern)

Burr-Brown Corporation  
 Suite 102  
 33 North Addison Road  
 Addison, IL 60101  
 Tel: (312) 832-6520  
 FAX: (312) 832-6531

## ILLINOIS (Southern)

B.C. Electronic Sales, Inc.  
 500 Airport Road  
 St. Louis, MO 63135  
 Tel: (314) 521-6683  
 TWX: 910-762-0600

## INDIANA

Burr-Brown Corporation  
 Suite 102  
 33 North Addison Road  
 Addison, IL 60101  
 Tel: (312) 832-6520  
 FAX: (312) 832-6531

## IOWA

Rep. Associates Corporation  
 4905 Lakeside Drive NE  
 Cedar Rapids, IA 52402  
 Tel: (319) 373-0152  
 FAX: (319) 373-0217

## KANSAS

B.C. Electronic Sales, Inc.  
 1140 Adams  
 Kansas City, KS 66103  
 Tel: (913) 342-1211  
 TWX: 910-749-6414

## KENTUCKY

Burr-Brown Corporation  
 Suites 313 & 315  
 10945 Reed Hartman Hwy.  
 Cincinnati, OH 45242  
 Tel: (513) 891-4711  
 FAX: (513) 891-4713

## LOUISIANA (Northern)

Burr-Brown Corporation  
 11882 Greenville Ave.  
 Suite 128, LB#16  
 Dallas, TX 75243  
 Tel: (214) 783-4555  
 FAX: (214) 783-2717

## LOUISIANA (Southern)

Burr-Brown Corporation  
 Suite 572  
 9888 Bissonnet  
 Houston, TX 77036  
 Tel: (713) 988-6546 or  
 (512) 473-2311 (Austin)  
 FAX: (713) 988-6548

## MAINE

Burr-Brown Corporation  
 Suite 3C  
 83 Cambridge Street  
 Burlington, MA 01803  
 Tel: (617) 273-9022  
 FAX: (617) 270-6899

## MARYLAND

Marktron Inc.  
 Suites 302 & 304  
 1688 East Gude Drive  
 Rockville, MD 20850  
 Tel: (301) 251-8990  
 TWX: 710-828-0089

## MASSACHUSETTS

Marktron Inc.  
 Suite 205  
 54 Scott Adam Road  
 Hunt Valley, MD 21030  
 Tel: (301) 628-1111  
 TWX: 710-232-1850  
 FAX: (301) 628-9351

## MASSACHUSETTS

Burr-Brown Corporation  
 Suite 3C  
 83 Cambridge Street  
 Burlington, MA 01803  
 Tel: (617) 273-9022  
 FAX: (617) 270-6899

## MICHIGAN

Burr-Brown Corporation  
 Suite 320  
 38345 W. Ten Mile Rd  
 Farmington, MI 48024  
 Tel: (313) 474-6533  
 FAX: (313) 474-7379

## MINNESOTA

Electronic Sales Agency Inc.  
 8053 Bloomington Freeway  
 Bloomington, MN 55420  
 Tel: (612) 884-8291  
 Telex: ITT 1034310015  
 L & M ESA  
 FAX: (612) 884-8294

## MISSISSIPPI

Rep. Inc.  
 PO Box 4889  
 11535 Gilleland Road  
 Huntsville, AL 35815-0889  
 Tel: (205) 881-9270  
 TWX: 810-726-2102  
 EZLINK 62608310  
 FAX: (205) 882-6692

## MISSOURI

B.C. Electronic Sales, Inc.  
 500 Airport Road  
 St. Louis, MO 63135  
 Tel: (314) 521-6683  
 TWX: 910-762-0600

## MONTANA

Aspen Sales Inc.  
 Suite 11  
 1817 South Main Street  
 Salt Lake City, UT 84115-2036  
 Tel: (801) 467-2401  
 TWX: EZLINK 62927519  
 FAX: (801) 467-2360

## NEBRASKA

B.C. Electronic Sales, Inc.  
 1140 Adams  
 Kansas City, KS 66103  
 Tel: (913) 342-1211  
 TWX: 910-749-6414

## NEVADA (Northern)

Burr-Brown Corporation  
 Suite 6  
 1975 Hamilton Avenue  
 San Jose, CA 95125  
 Tel: (408) 559-8600  
 FAX: (408) 559-0354

## NEVADA (Southern)

Burr-Brown Corporation  
 Suite 112  
 28310 Roadside Drive  
 Agoura, CA 91301  
 Tel: (818) 991-8544 or  
 (805) 496-7581  
 FAX: (818) 991-7872

## NEW HAMPSHIRE

Burr-Brown Corporation  
 Suite 3C  
 83 Cambridge Street  
 Burlington, MA 01803  
 Tel: (617) 273-9022  
 FAX: (617) 270-6899

## NEW JERSEY

Burr-Brown Corporation  
 Suite 402  
 984 North Broadway  
 Yonkers, NY 10701  
 Tel: (914) 964-5252  
 FAX: (914) 964-0655

## NEW MEXICO

Thorsen Desert States Inc.  
 Suite 112  
 9301 Indian School N.E.  
 Albuquerque, NM 87112  
 Tel: (505) 293-8555  
 TWX: 910-989-1174 or  
 EZLINK 62933749  
 FAX: (505) 296-5802

## NEW YORK (Metro Area)

Burr-Brown Corporation  
 Suite 402  
 984 North Broadway  
 Yonkers, NY 10701  
 Tel: (914) 964-5252  
 FAX: (914) 964-0655

## NEW YORK

Advanced Components  
 Corporation  
 PO Box 276  
 Syracuse, NY 13212-0276  
 Tel: (315) 699-2671  
 FAX: (315) 699-4611

## NEW YORK

Advanced Components  
 Corporation  
 PO Box 645  
 948 Sarah Lane  
 Endicott, NY 13760  
 Tel: (607) 785-3191

## NEW YORK

Advanced Components  
 Corporation  
 PO Box 142  
 775 Wheatland Road  
 Scottsville, NY 14546  
 Tel: (716) 889-1429

## NEW YORK

Advanced Components  
 Corporation  
 PO Box 17182  
 Rochester, NY 14617-0182  
 Tel: (716) 544-7017

## NEW YORK

Advanced Components  
 Corporation  
 Limerick Road  
 Clinton, NY 13323  
 Tel: (315) 853-6438

## NORTH CAROLINA

Murcola Corporation  
 1106 Burke Street  
 Winston-Salem, NC 27101  
 Tel: (919) 722-9445  
 TWX: 510-931-3101  
 FAX: (919) 722-9447

## NORTH DAKOTA

Electronic Sales Agency Inc.  
 8053 Bloomington Freeway  
 Bloomington, MN 55420  
 Tel: (612) 884-8291  
 Telex: ITT 1034310015  
 L & M ESA  
 FAX: (612) 884-8294

## OHIO

Burr-Brown Corporation  
 Suites 313 & 315  
 10945 Reed Hartman Hwy.  
 Cincinnati, OH 45242  
 Tel: (513) 891-4711  
 FAX: (513) 891-4713

## OHIO (Northeast)

K-T/DEPCO Marketing Inc.  
 11 Alpha Circle  
 Cleveland, OH 44143  
 Tel: (216) 442-6200  
 FAX: (216) 461-2101  
 TWX: EZLINK 62456110

## OKLAHOMA

Burr-Brown Corporation  
 11882 Greenville Ave.  
 Suite 128, LB#16  
 Dallas, TX 75243  
 Tel: (214) 783-4555  
 FAX: (214) 783-2717

## OREGON

Burr-Brown Corporation  
 523 S. Washington Ave.  
 Kent, WA 98032  
 Tel: (206) 859-9220  
 FAX: (206) 859-9276

## PENNSYLVANIA (Western)

K-T/DEPCO Marketing Inc.  
 1520 Northway Mall  
 Pittsburgh, PA 15237  
 Tel: (412) 367-1011

## PENNSYLVANIA (Eastern)

QED Electronics Inc.  
 PO Box 487  
 805 North Bethlehem Pike  
 Spring House, PA 19477  
 Tel: (215) 643-9200  
 TWX: EZLINK 62931798  
 FAX: (215) 643-9213

## RHODE ISLAND

Burr-Brown Corporation  
 Suite 3C  
 83 Cambridge Street  
 Burlington, MA 01803  
 Tel: (617) 273-9022  
 FAX: (617) 270-6899

## SOUTH CAROLINA

Murcola Corporation  
 1106 Burke Street  
 Winston-Salem, NC 27101  
 Tel: (919) 722-9445  
 TWX: 510-931-3101  
 FAX: (919) 722-9447

## SOUTH DAKOTA

Electronic Sales Agency Inc.  
 8053 Bloomington Freeway  
 Bloomington, MN 55420  
 Tel: (612) 884-8291  
 Telex: ITT 1034310015  
 L & M ESA  
 FAX: (612) 884-8294

## TENNESSEE

Rep. Inc.  
 PO Box 728  
 113 South Branner Street  
 Jefferson City, TN 37760  
 Tel: (615) 475-4105  
 TWX: 810-570-0822  
 FAX: (615) 475-6340

## TEXAS (Northern)

Burr-Brown Corporation  
 11882 Greenville Ave.  
 Suite 128, LB#16  
 Dallas, TX 75243  
 Tel: (214) 783-4555  
 FAX: (214) 783-2717

## TEXAS (Southern)

Burr-Brown Corporation  
 Suite 572  
 9888 Bissonnet  
 Houston, TX 77036  
 Tel: (713) 988-6546 or  
 (512) 473-2311 (Austin)  
 FAX: (713) 988-6548

## TEXAS (El Paso)

Thorsen Desert States Inc.  
 Suite 112  
 9301 Indian School N.E.  
 Albuquerque, NM 87112  
 Tel: (505) 293-8555  
 TWX: 910-989-1174  
 EZLINK 62933749  
 FAX: (505) 296-5802

## UTAH

Aspen Sales Inc.  
 Suite 11  
 1817 South Main Street  
 Salt Lake City, UT 84115-2036  
 Tel: (801) 467-2401  
 TWX: EZLINK 62927519  
 FAX: (801) 467-2360

## VERMONT

Burr-Brown Corporation  
 Suite 3C  
 83 Cambridge Street  
 Burlington, MA 01803  
 Tel: (617) 273-9022  
 FAX: (617) 270-6899

## VIRGINIA

Marktron Inc.  
 Suites 302 & 304  
 1688 East Gude Drive  
 Rockville, MD 20850  
 Tel: (301) 251-8990  
 TWX: 710-828-0089

## VIRGINIA

Marktron Inc.  
 Suite 206  
 54 Scott Adam Road  
 Hunt Valley, MD 21030  
 Tel: (301) 628-1111  
 TWX: 710-232-1850  
 FAX: (301) 628-9351

## WASHINGTON

Burr-Brown Corporation  
 523 S. Washington Ave.  
 Kent, WA 98032  
 Tel: (206) 859-9220  
 FAX: (206) 859-9276

## WASHINGTON, D.C.

Marktron Inc.  
 Suites 302 & 304  
 1688 East Gude Drive  
 Rockville, MD 20850  
 Tel: (301) 251-8990  
 TWX: 710-828-0089

## WASHINGTON

Marktron Inc.  
 Suite 206  
 54 Scott Adam Road  
 Hunt Valley, MD 21030  
 Tel: (301) 628-1111  
 TWX: 710-232-1850  
 FAX: (301) 628-9351

## WEST VIRGINIA

Burr-Brown Corporation  
 Suites 313 & 315  
 10945 Reed Hartman Hwy.  
 Cincinnati, OH 45242  
 Tel: (513) 891-4711  
 FAX: (513) 891-4713

## WISCONSIN (Eastern)

Burr-Brown Corporation  
 Suite 102  
 33 North Addison Road  
 Addison, IL 60101  
 Tel: (312) 832-6520  
 FAX: (312) 832-6531

## WISCONSIN (Western)

Electronic Sales Agency Inc.  
 8053 Bloomington Freeway  
 Bloomington, MN 55420  
 Tel: (612) 884-8291  
 Telex: ITT 1034310015  
 L & M ESA  
 FAX: (612) 884-8294

## WYOMING

Aspen Sales Inc.  
 Suite 11  
 1817 South Main Street  
 Salt Lake City, UT 84115-2036  
 Tel: (801) 467-2401  
 TWX: EZLINK 62927519  
 FAX: (801) 467-2360

For Immediate Product Information, Call (800) 548-6132

**Burr-Brown Corporation**  
International Airport Industrial Park

Street Address:  
6730 S. Tucson Blvd.  
Tucson, AZ 85706

Mailing Address:  
P.O. Box 11400  
Tucson, AZ 85734

Tel: (602) 746-1111  
Twx: 910-952-1111  
Cable: BBRCORP  
Telex: 066-6491  
FAX: (602) 889-1510

FOR IMMEDIATE PRODUCT  
INFORMATION: (800) 548-6132

Printed in U.S.A.

©1989 Burr-Brown Corporation